

R7

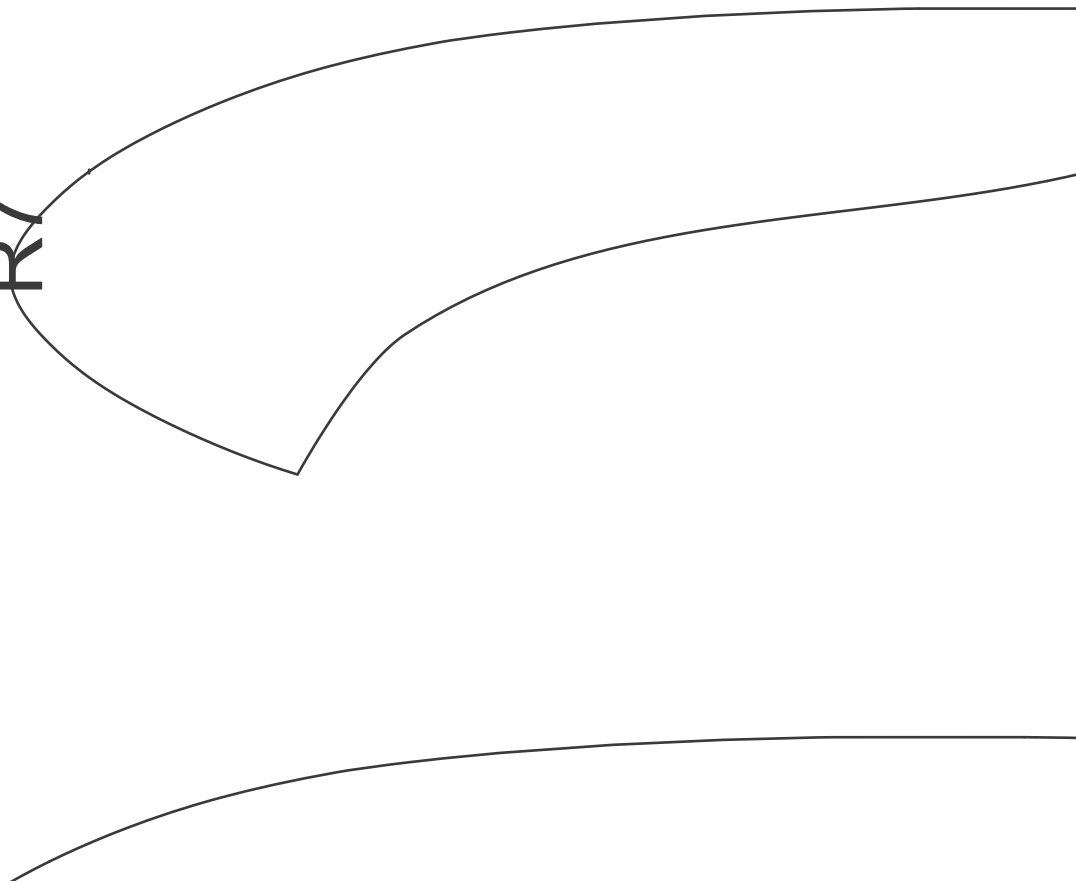

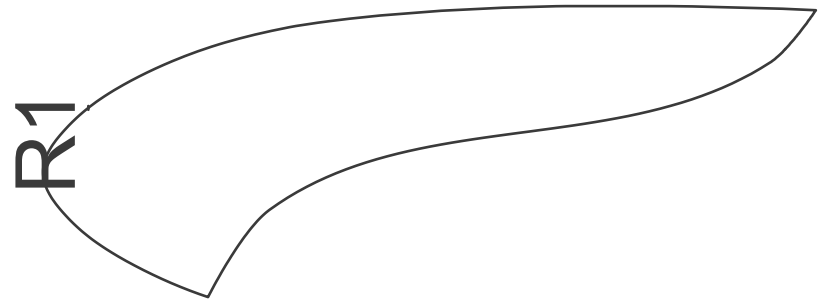

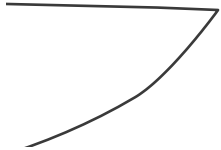

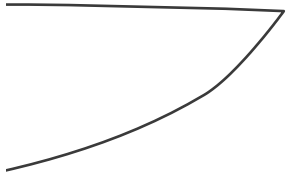
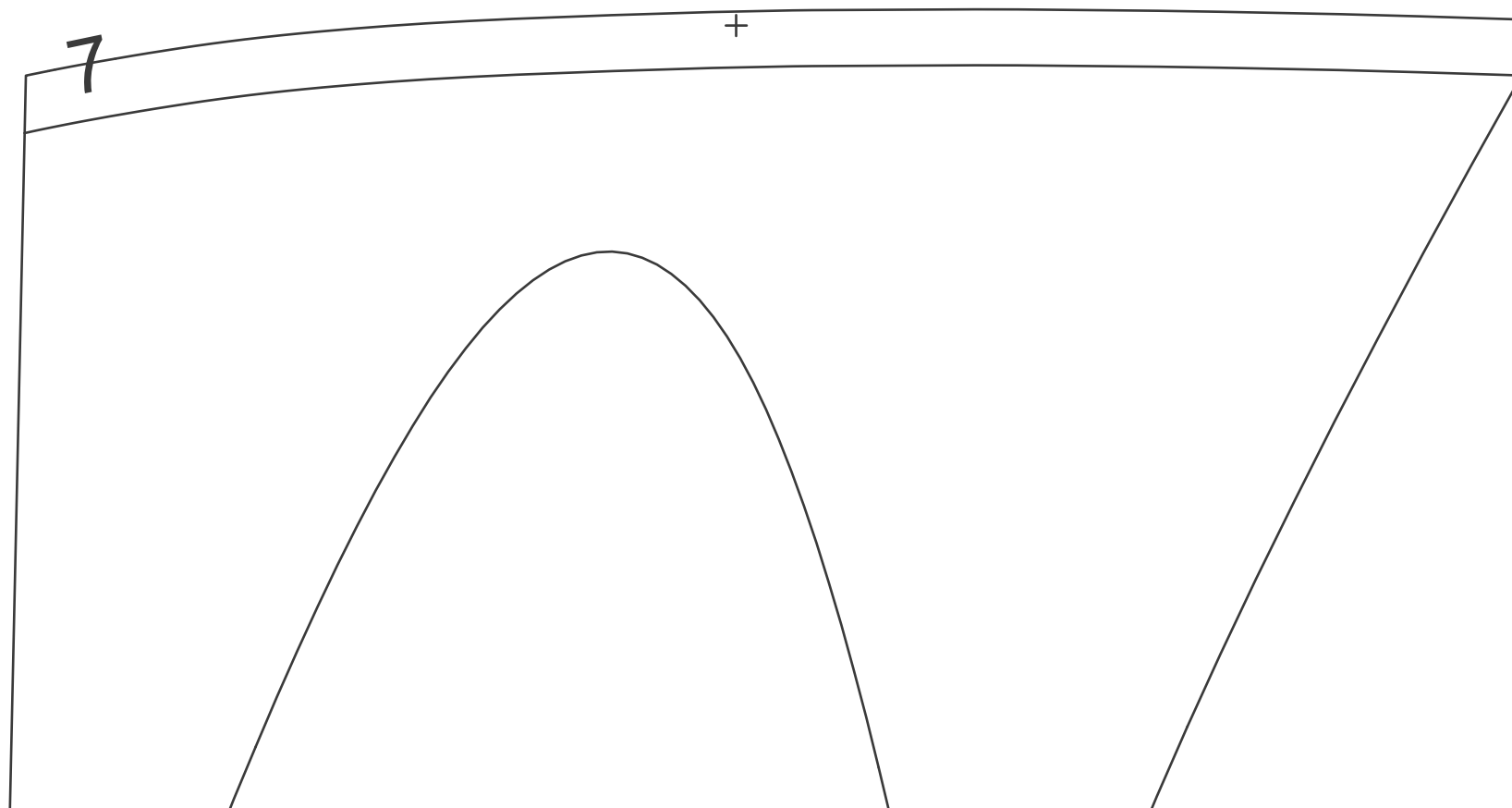
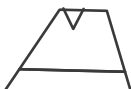



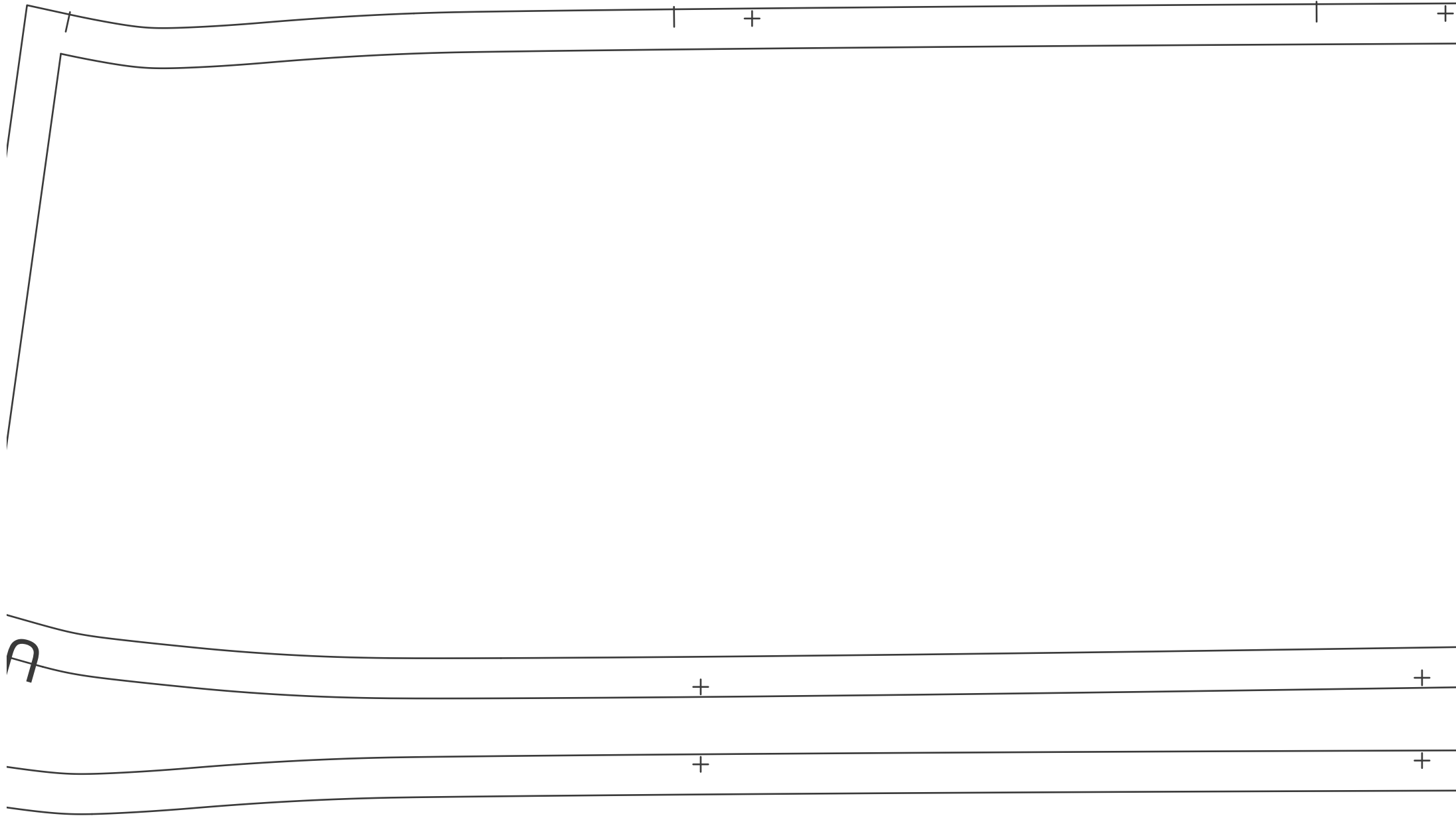

+

+

+



S

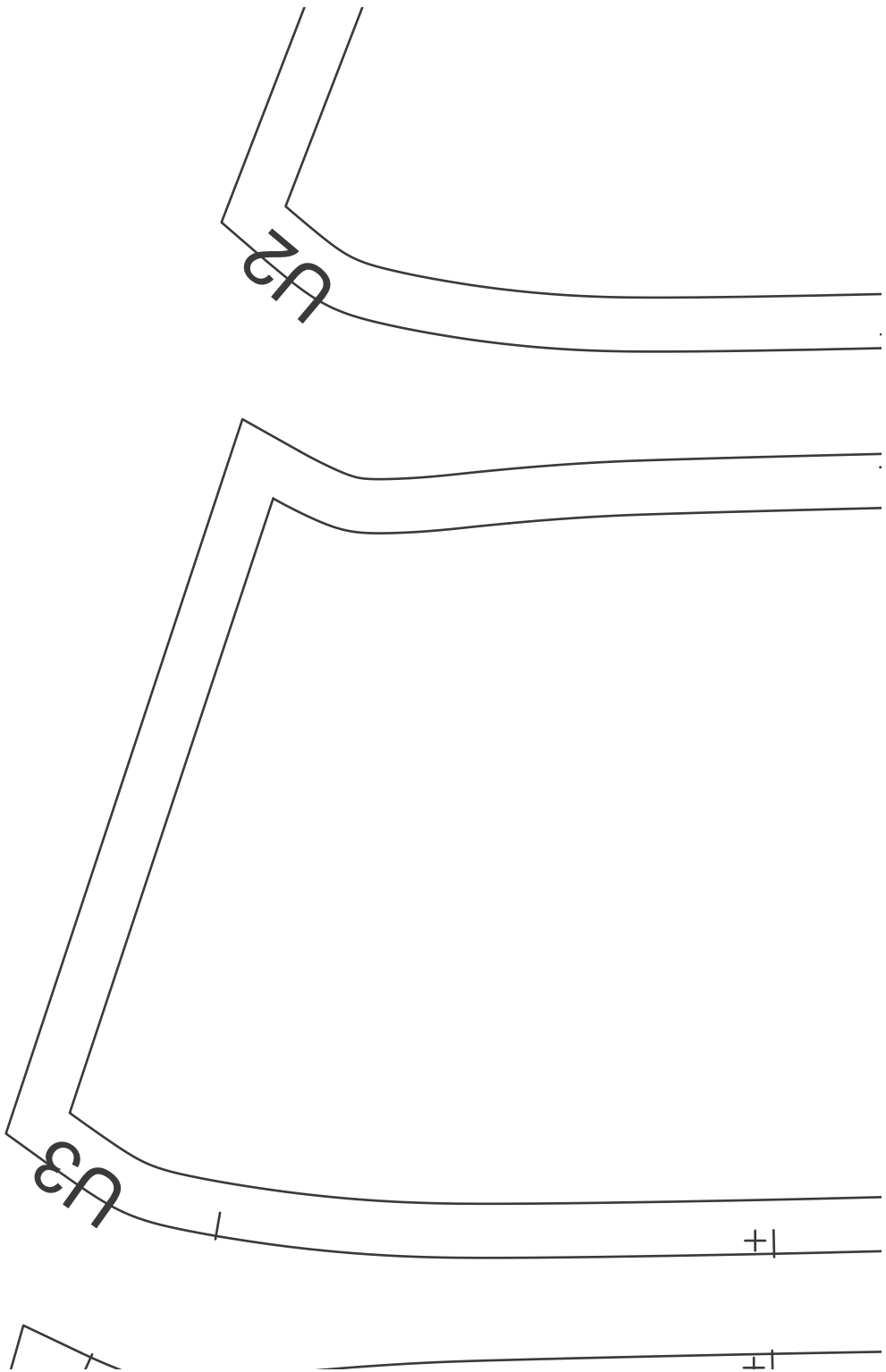

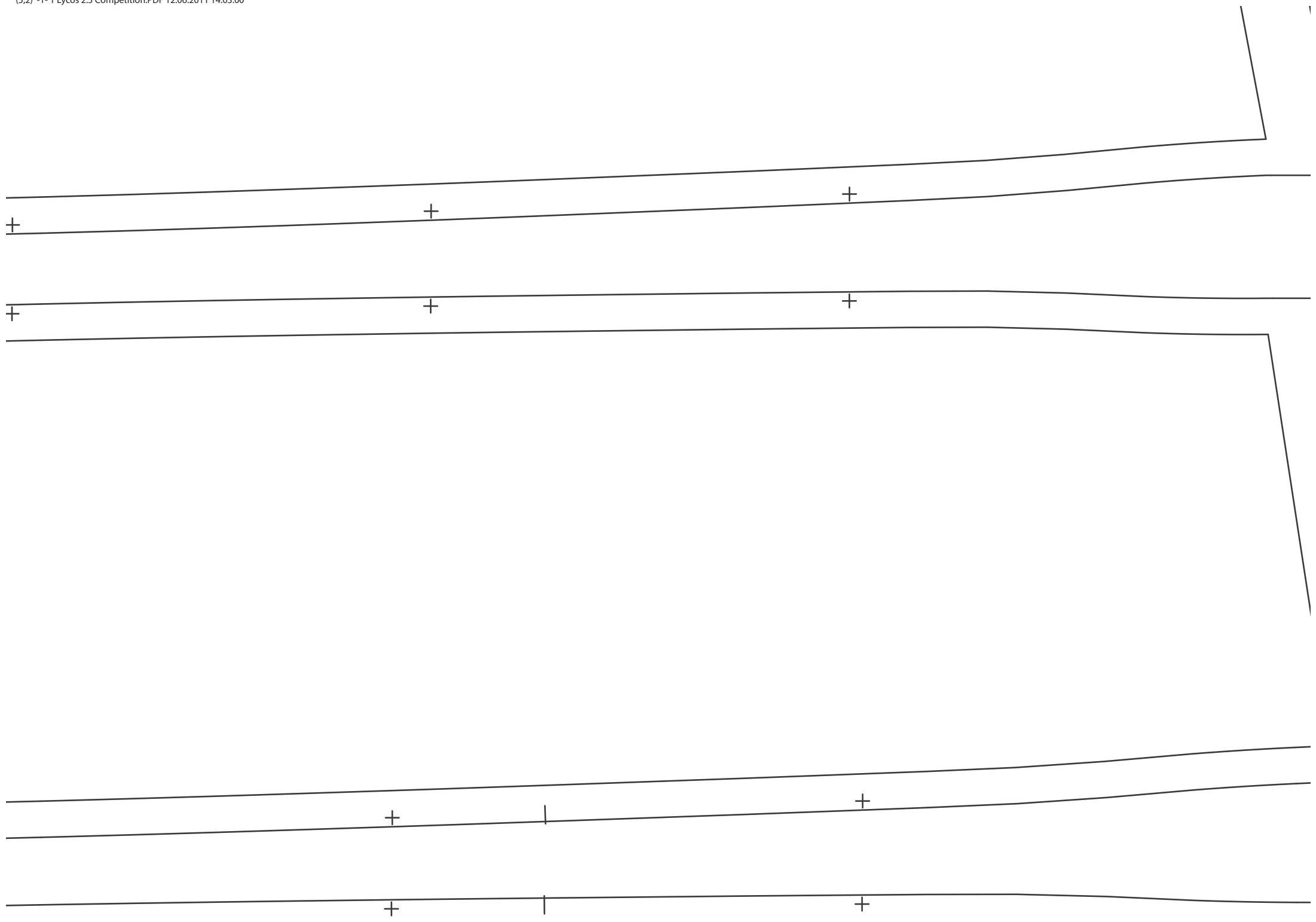

27 +

+

87 ^ | + | ^ |

| v | + | v |

+

+

+

+

+

|

|

+

+

|

|

+

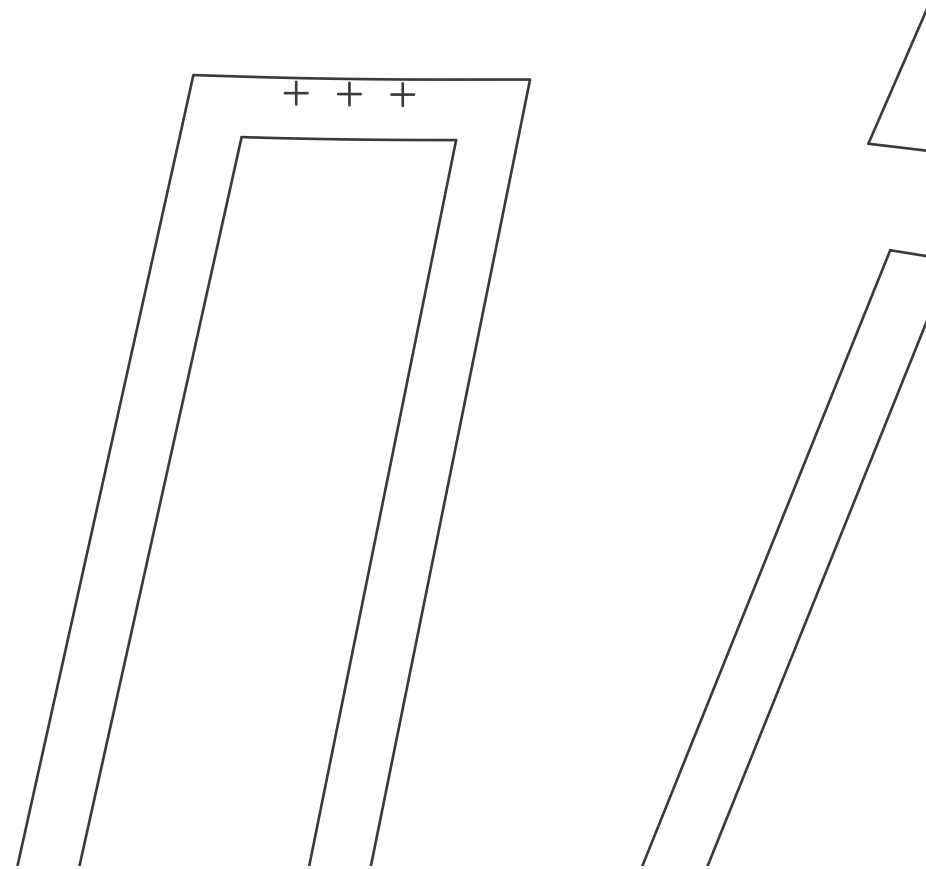
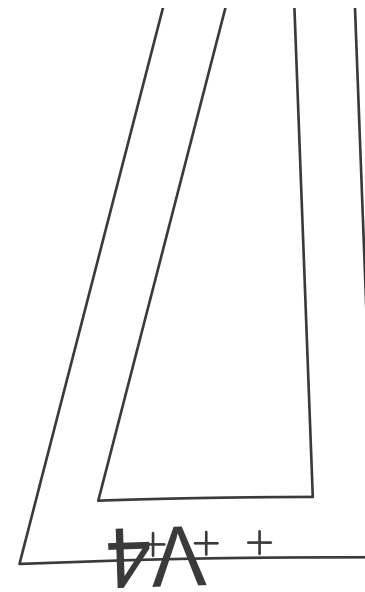
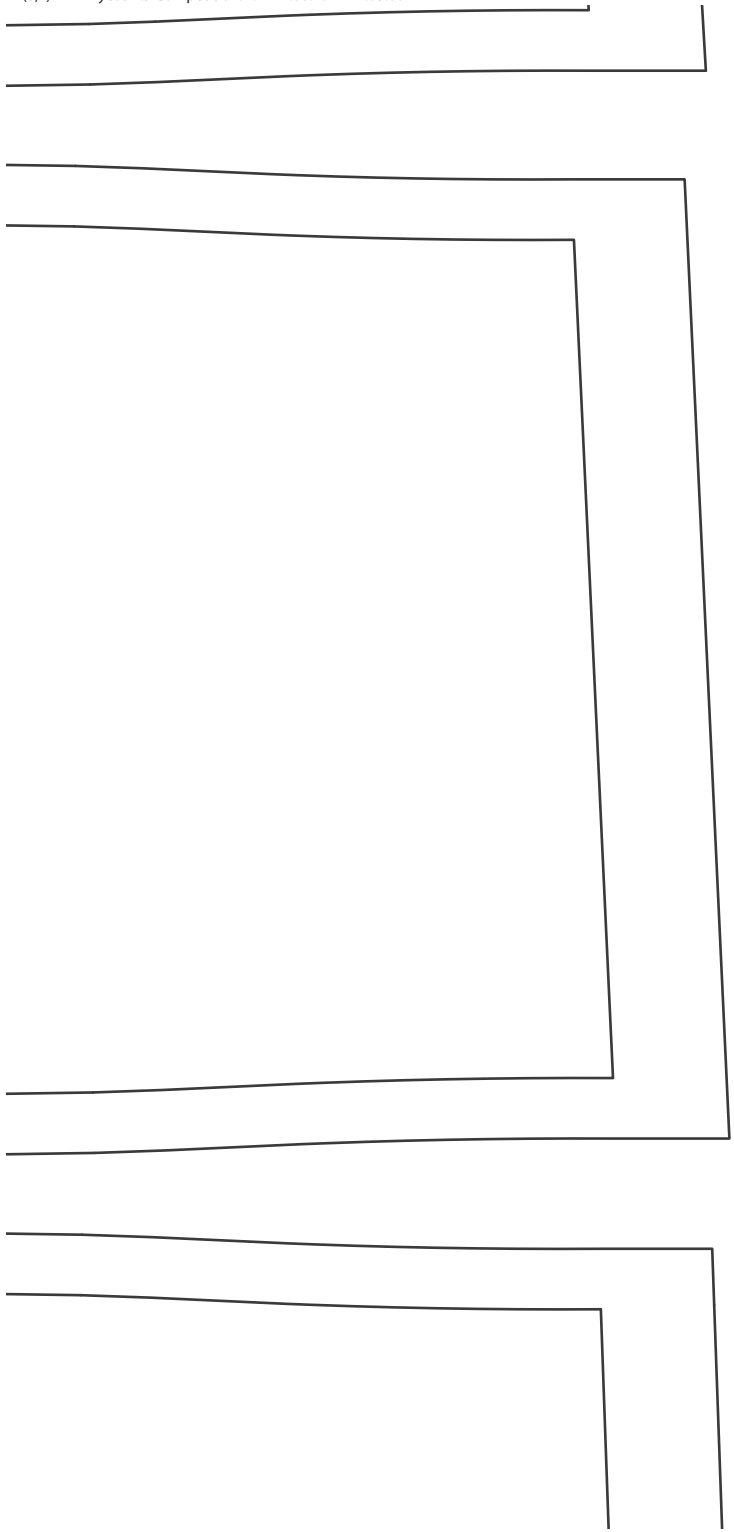

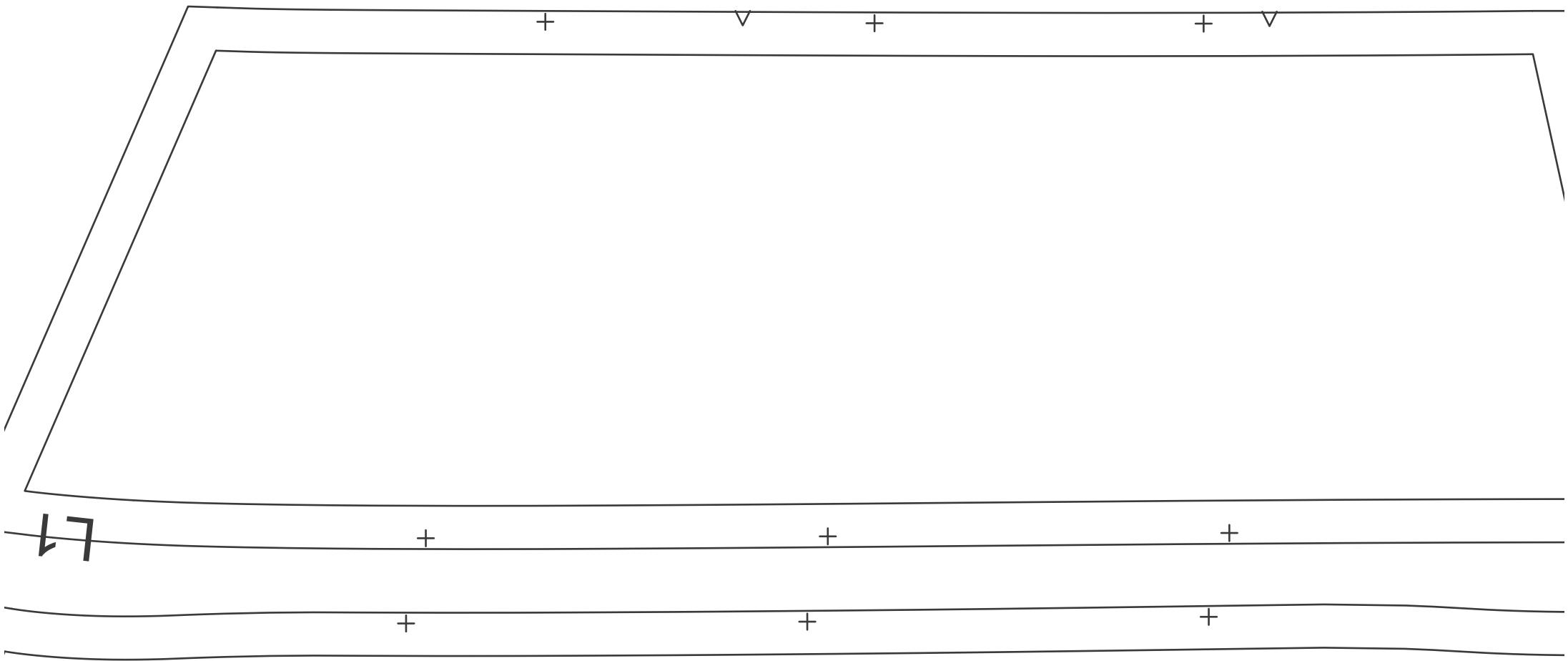

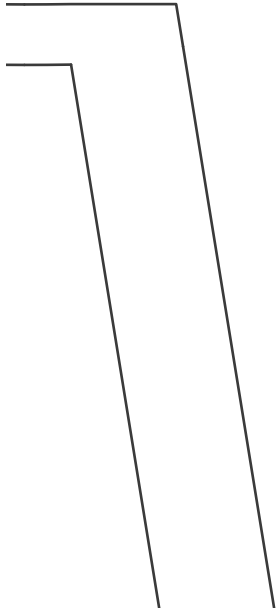
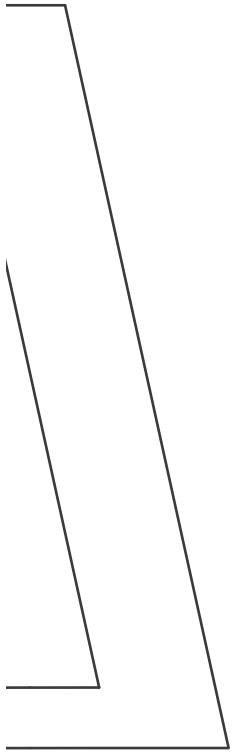

P7

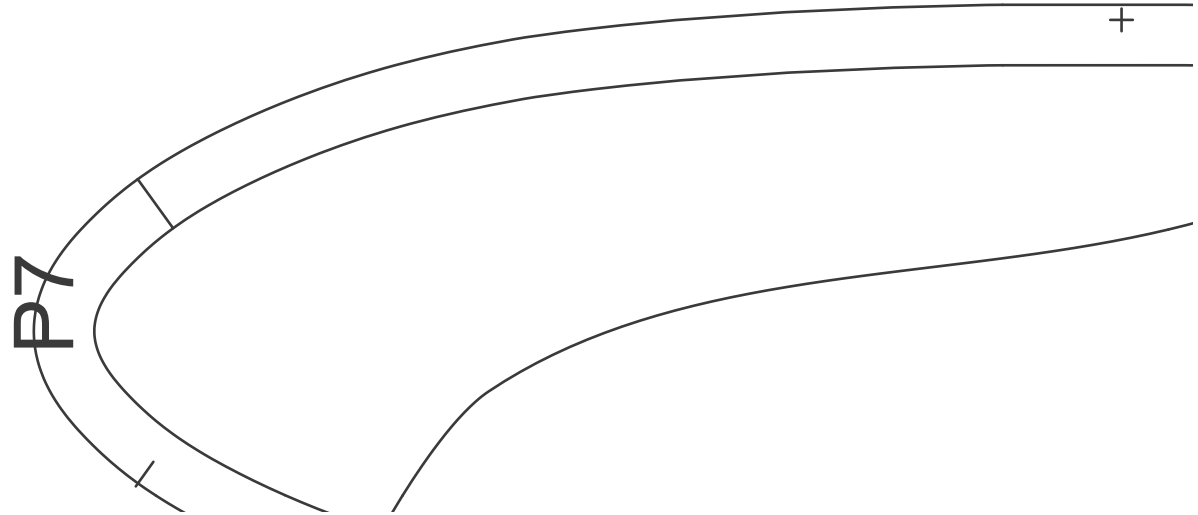

P6

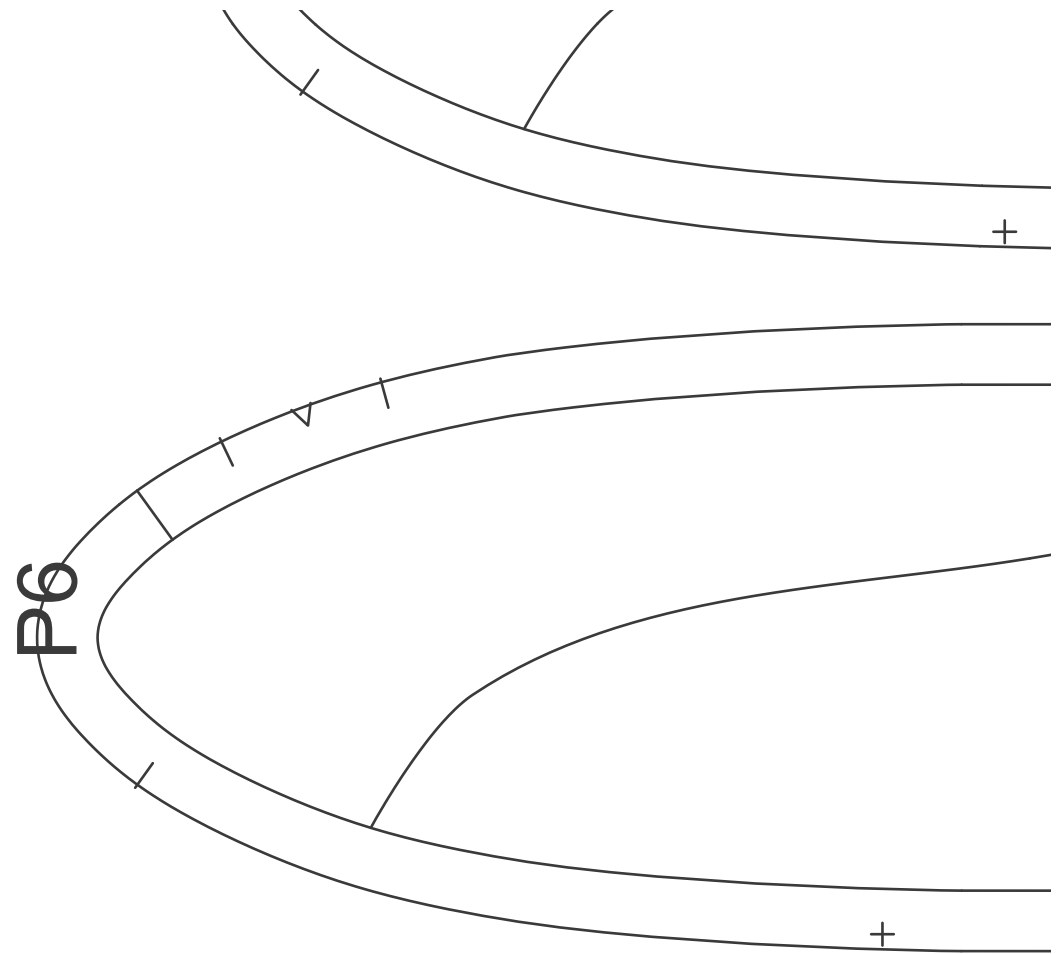

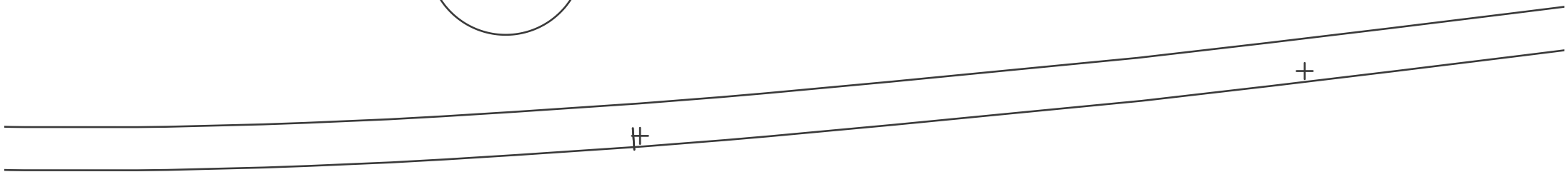

+ | v |

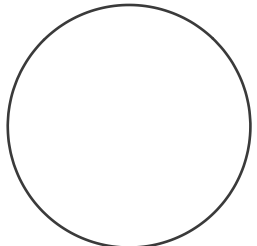
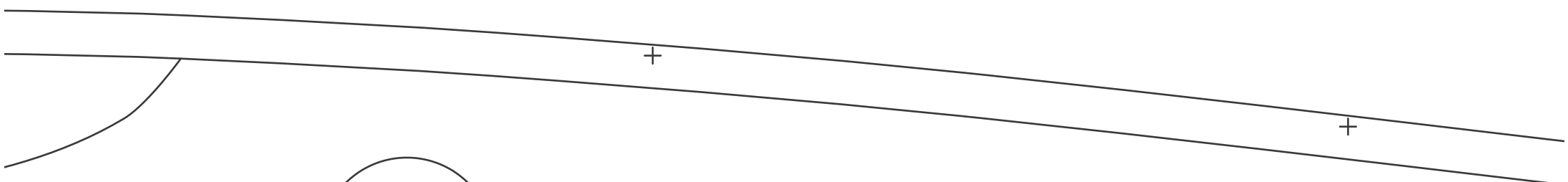
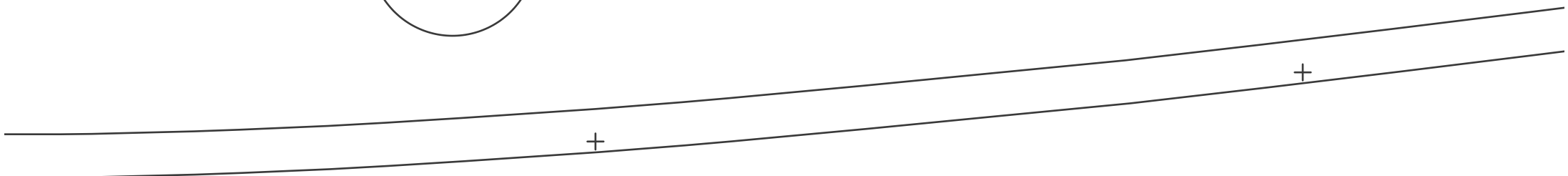
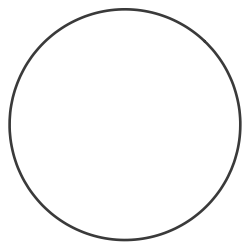
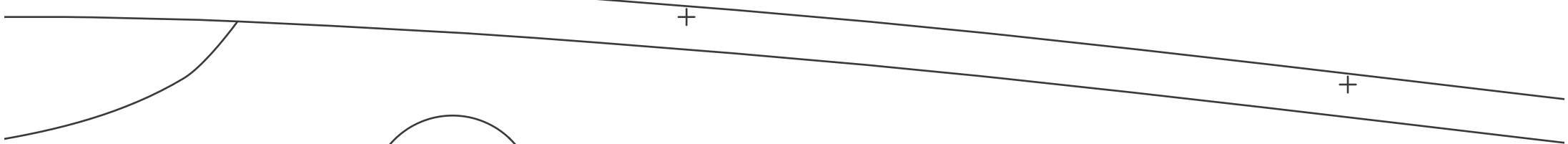

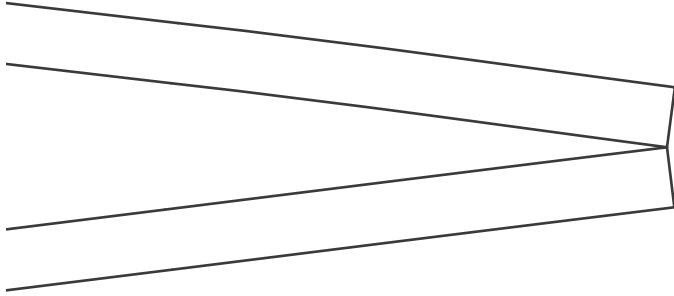
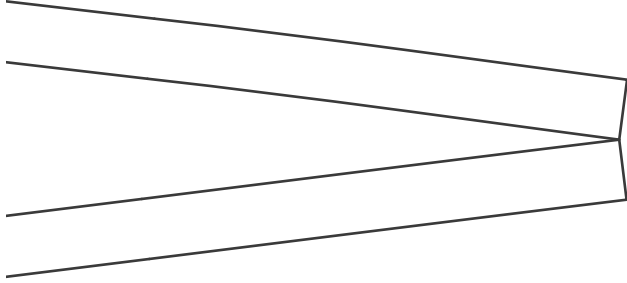

R8

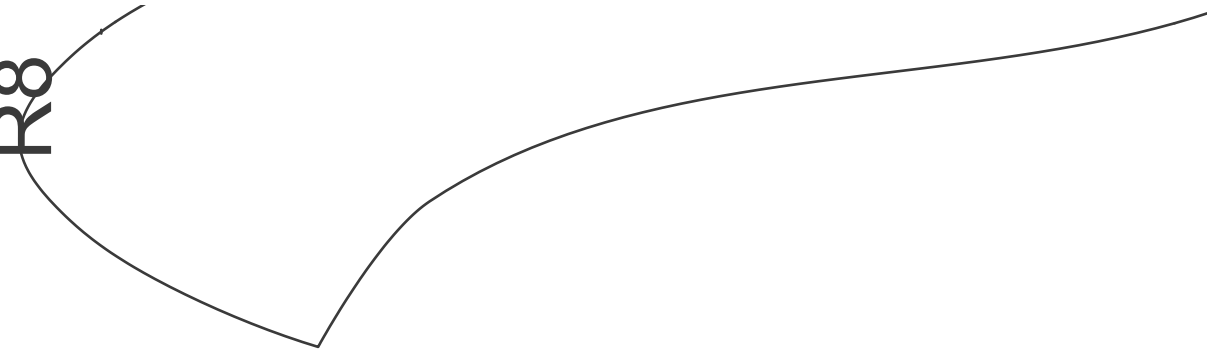

R9

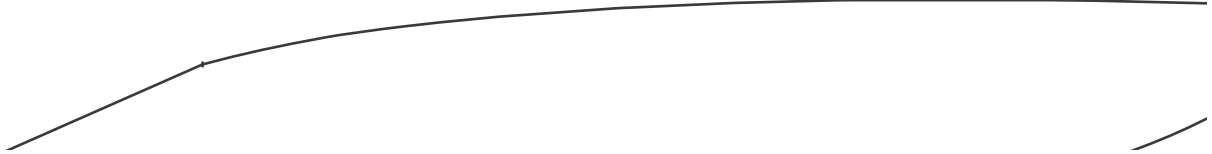
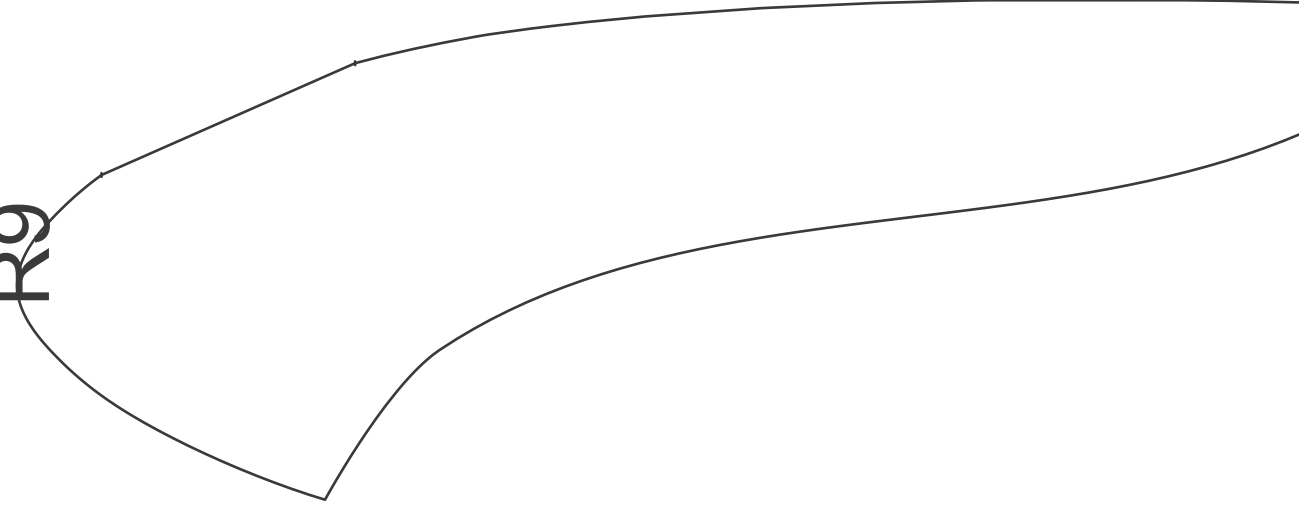

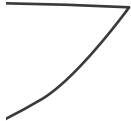
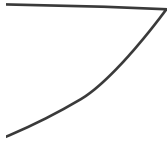

R3

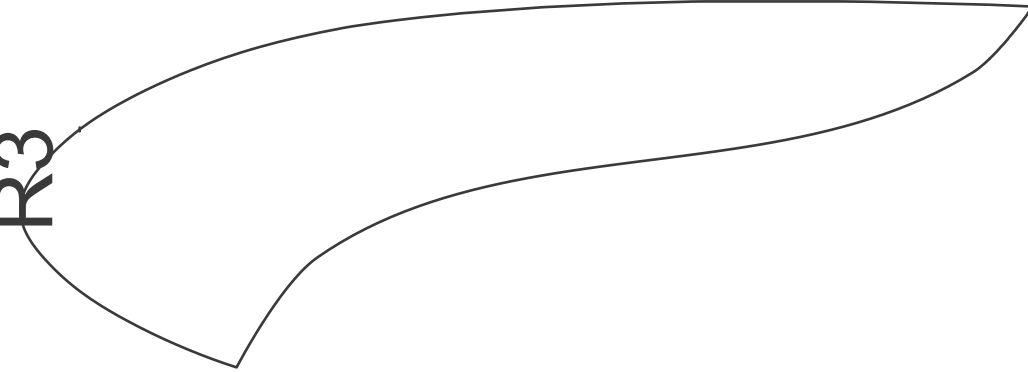

R2

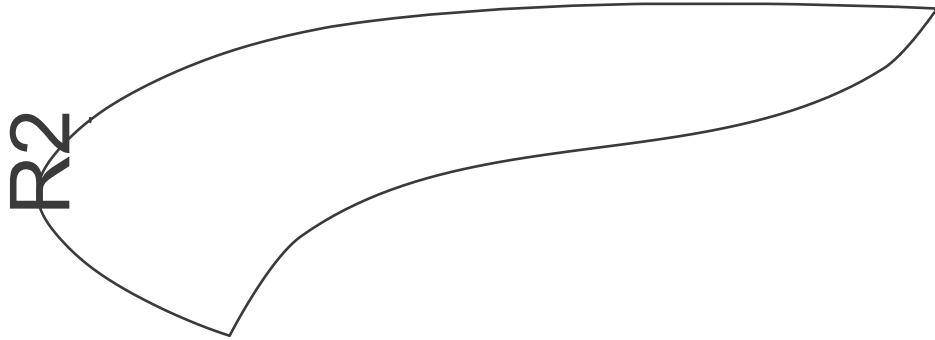

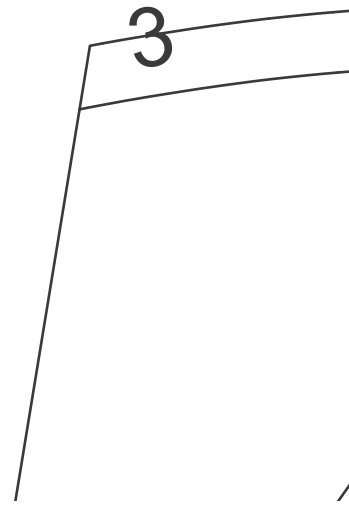
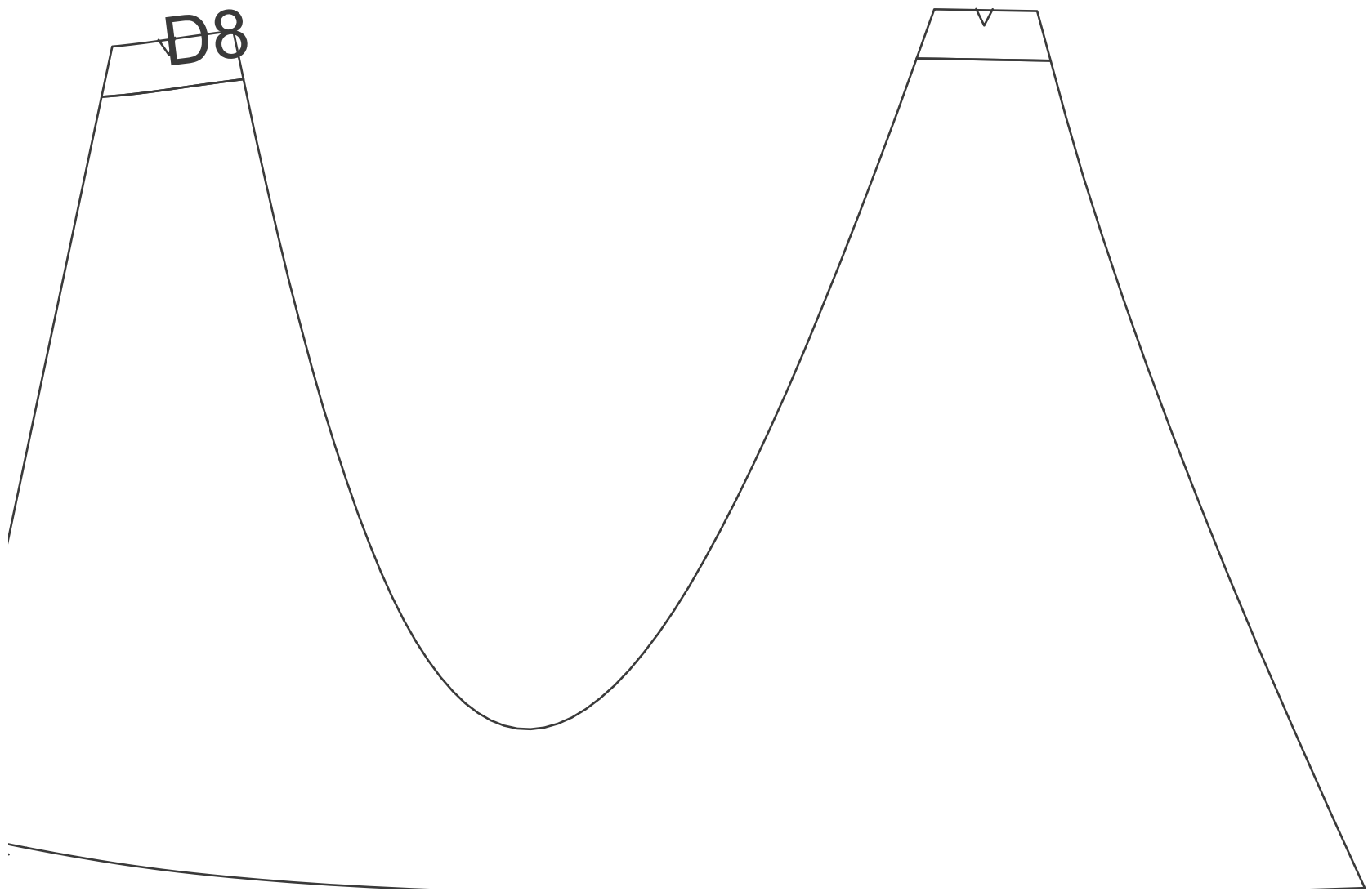
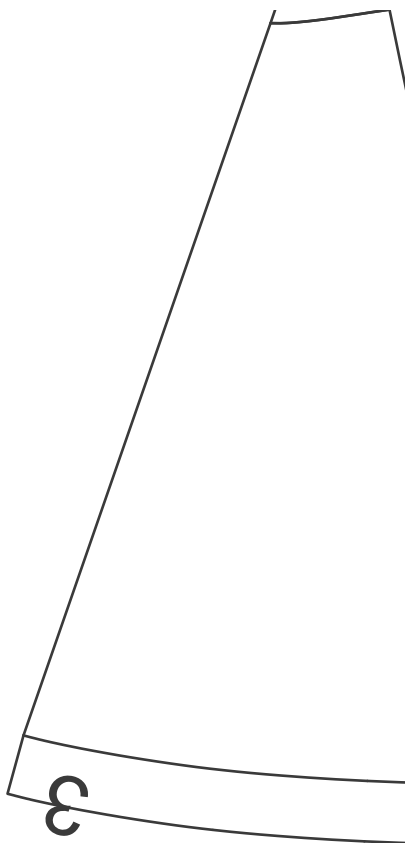
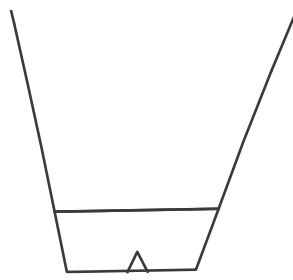
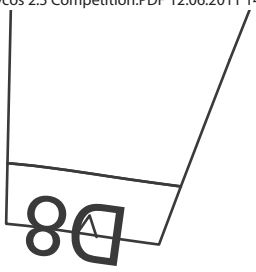

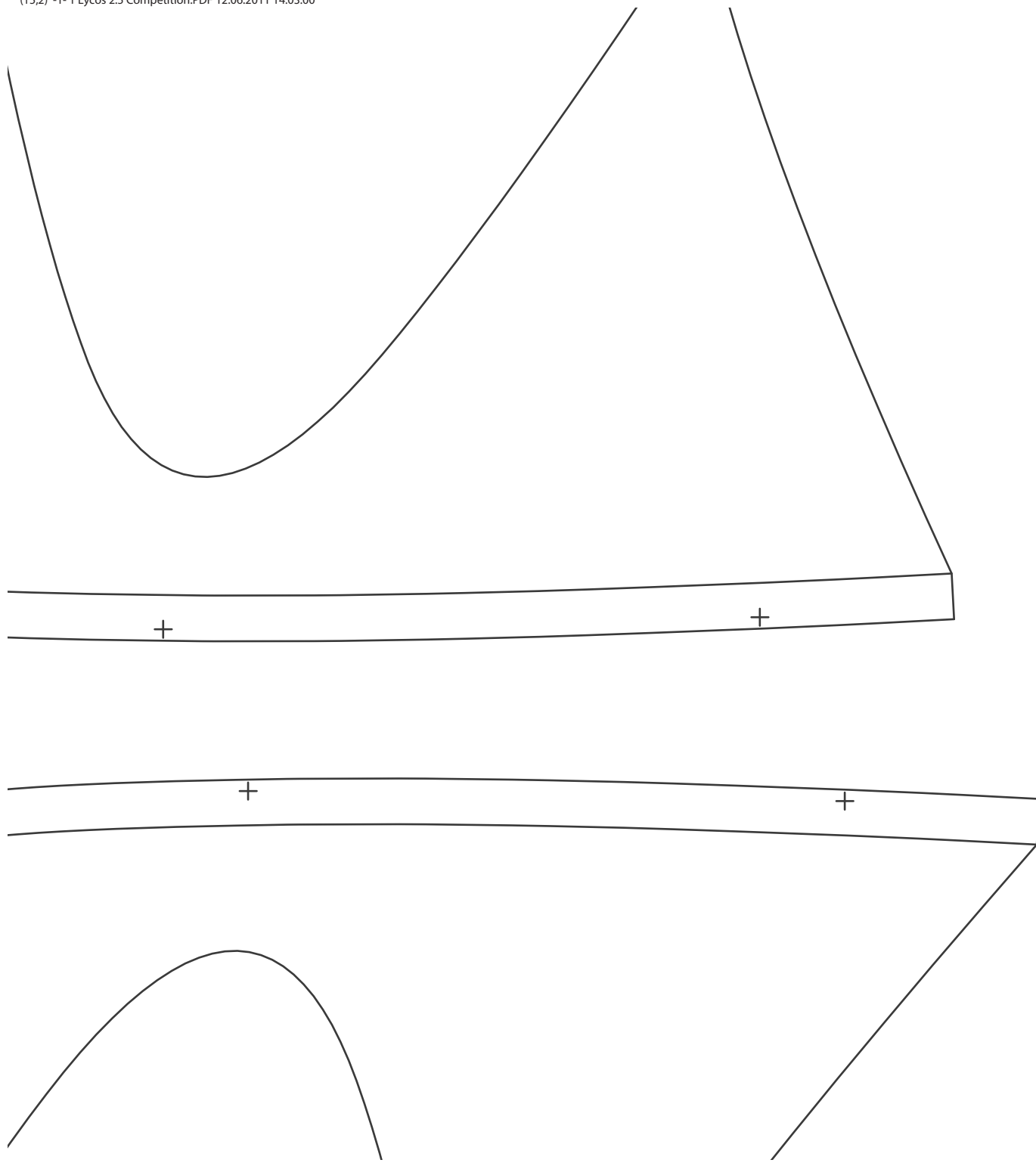

6n



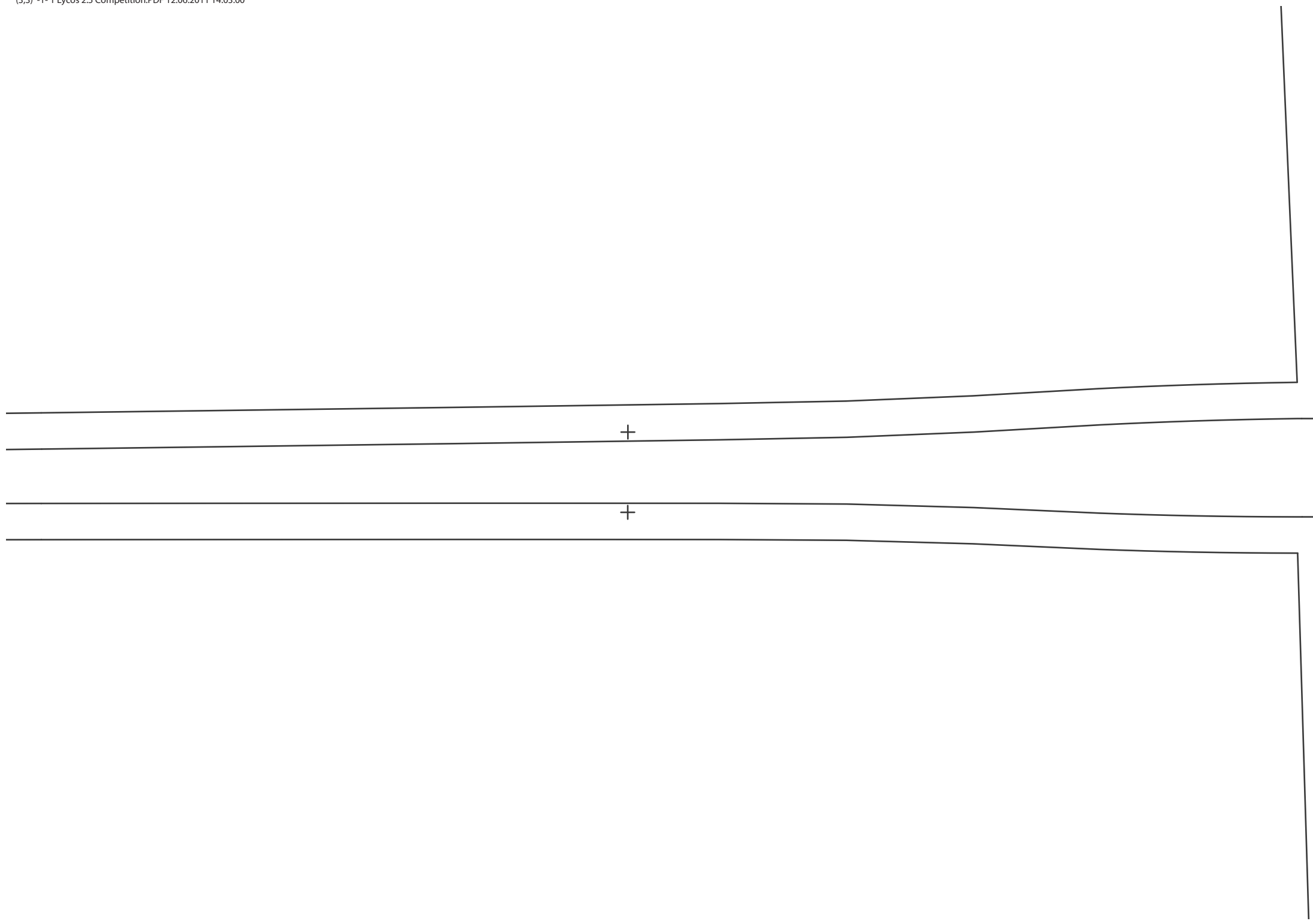

**SENABGLEICH
ES FELD IST 500 / 50 MM GROS**

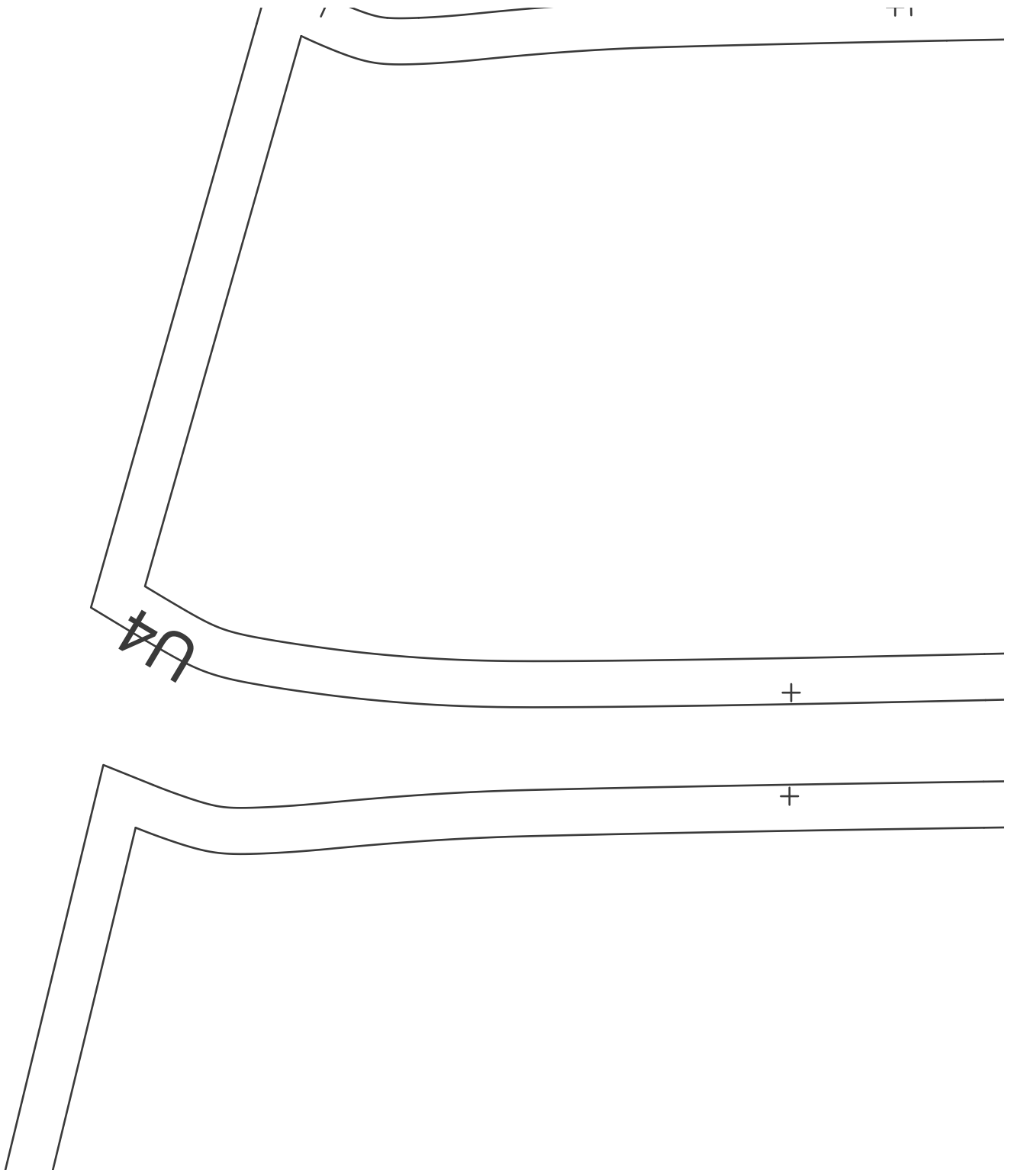

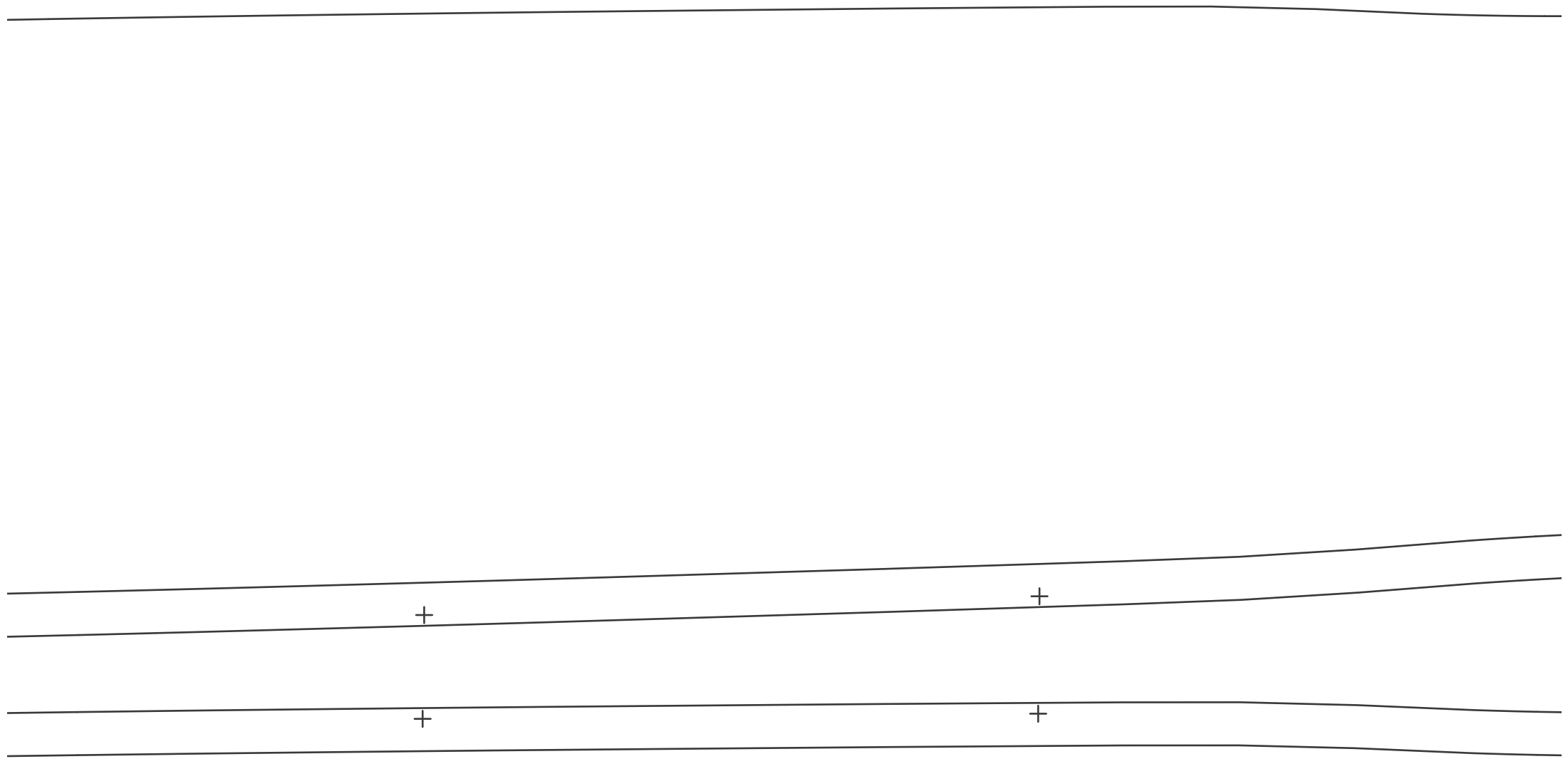

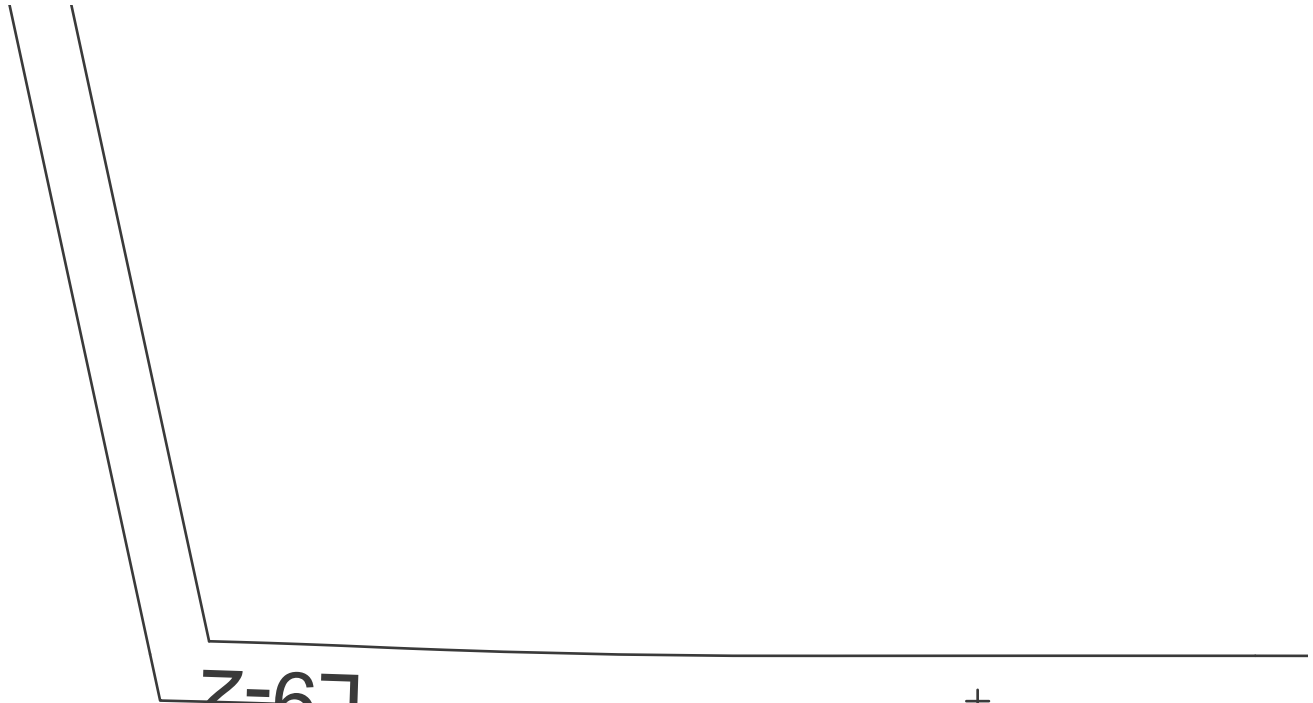
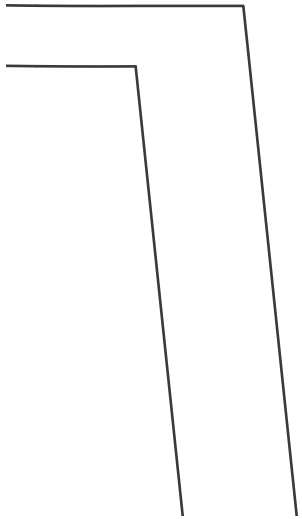
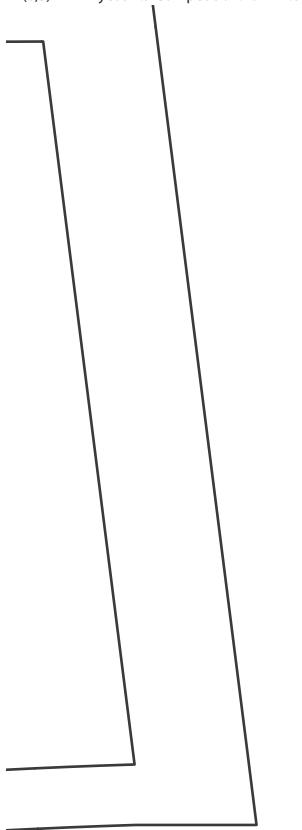

L9-2

+

+

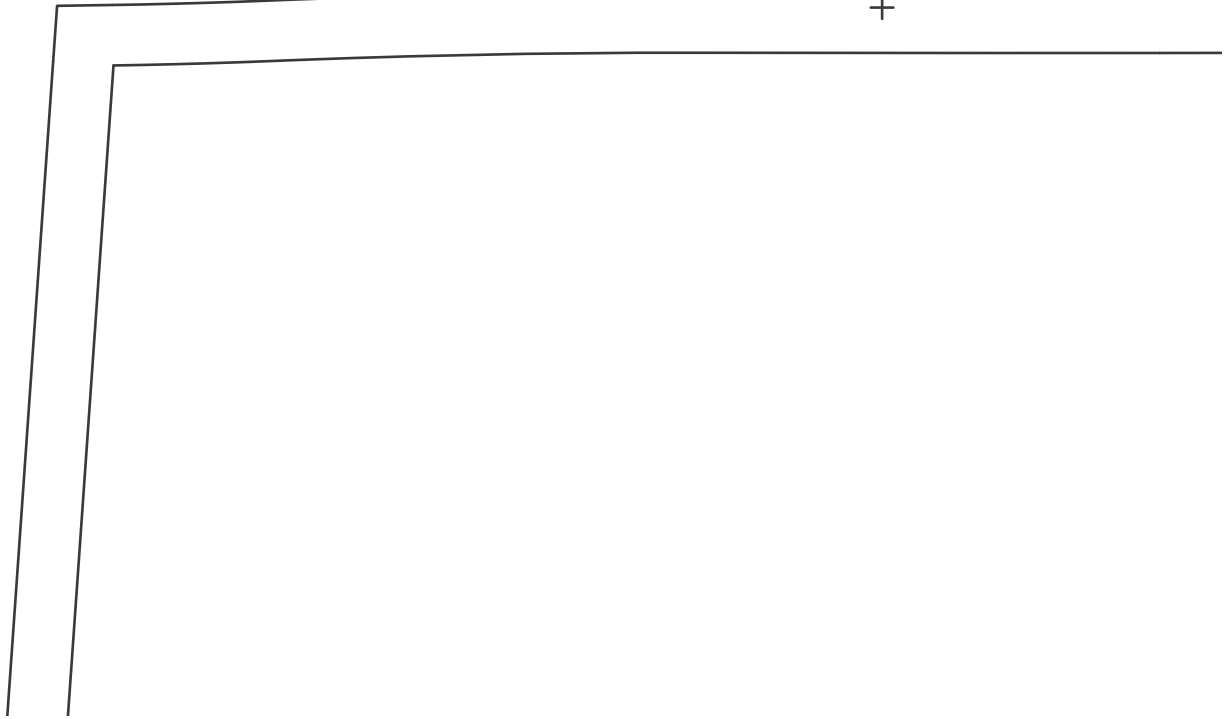

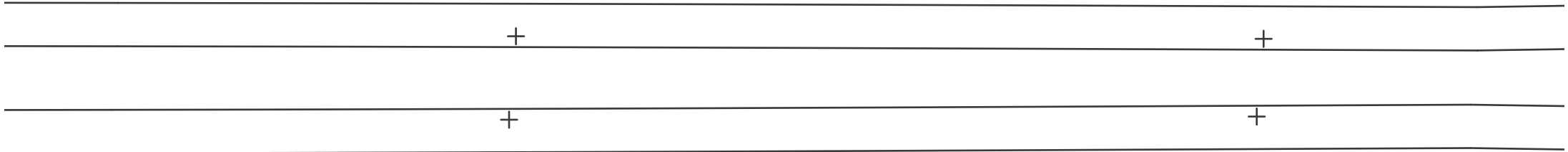

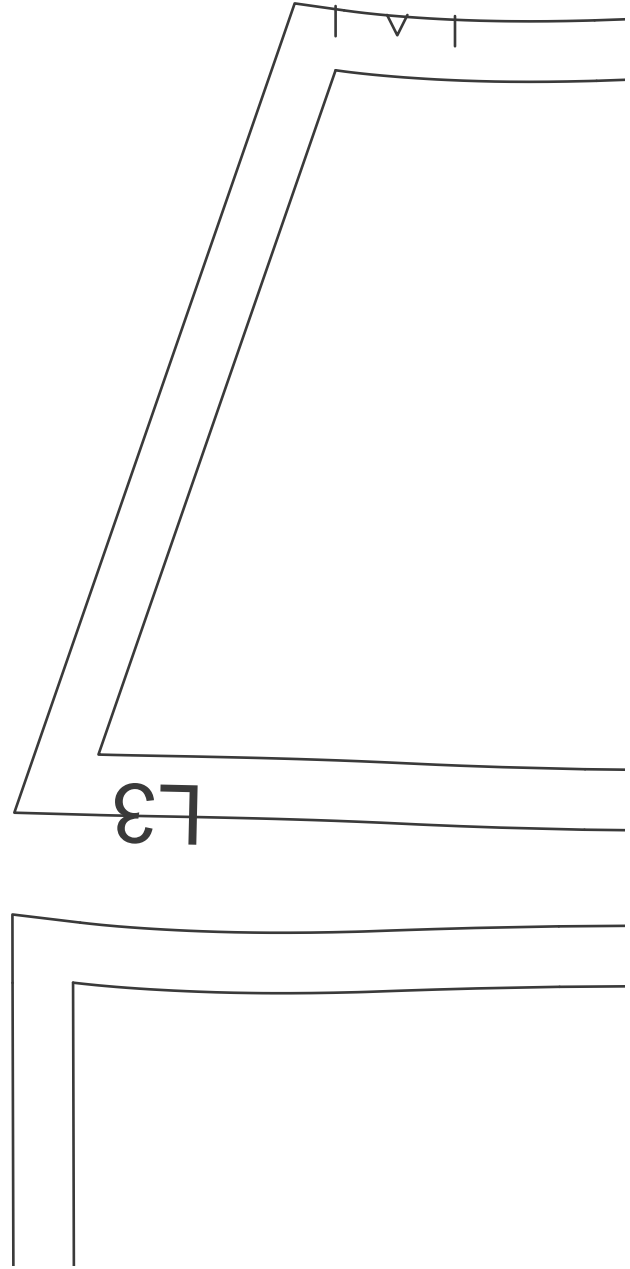
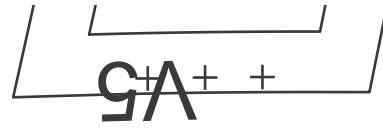
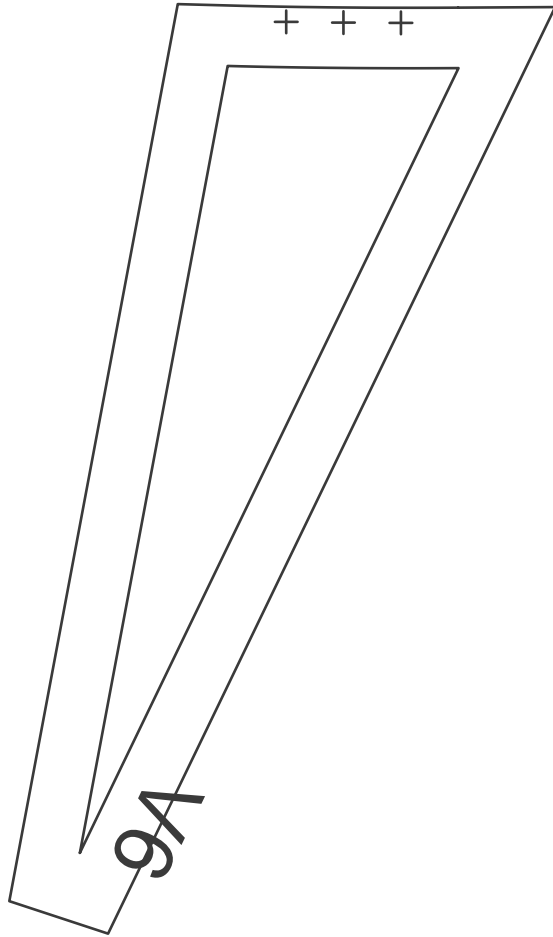
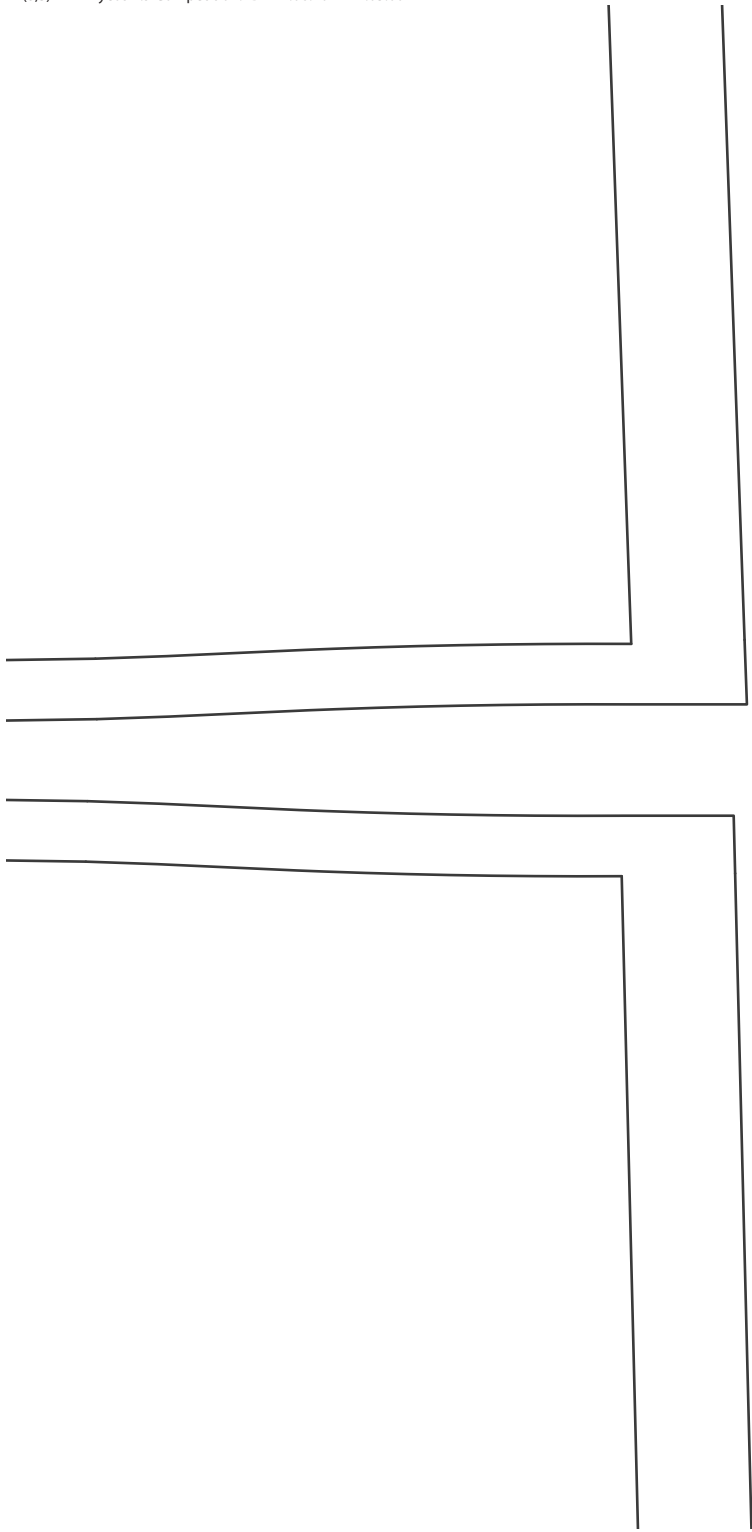

+

| ^ |

+

+ | |

+

| v |

+

+ | |

+

+

+

+

+

+

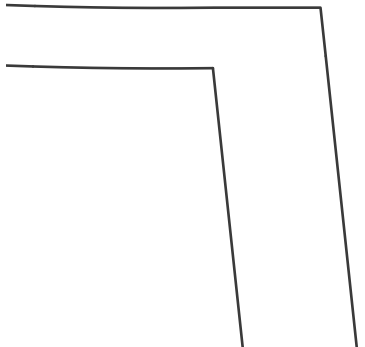
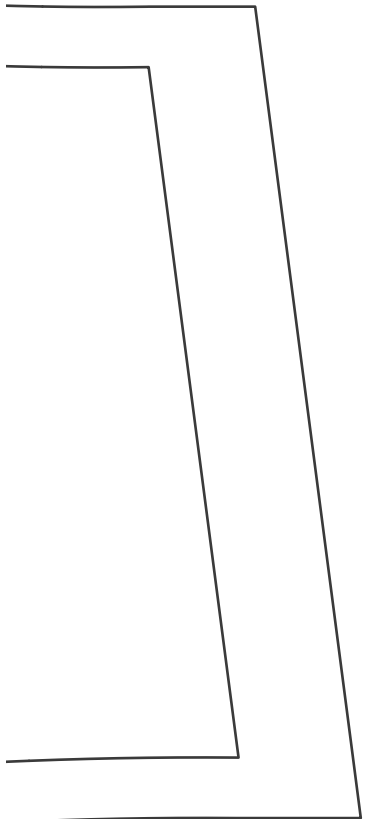
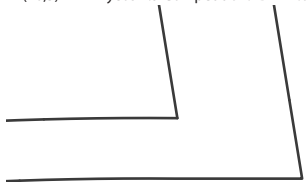

P8

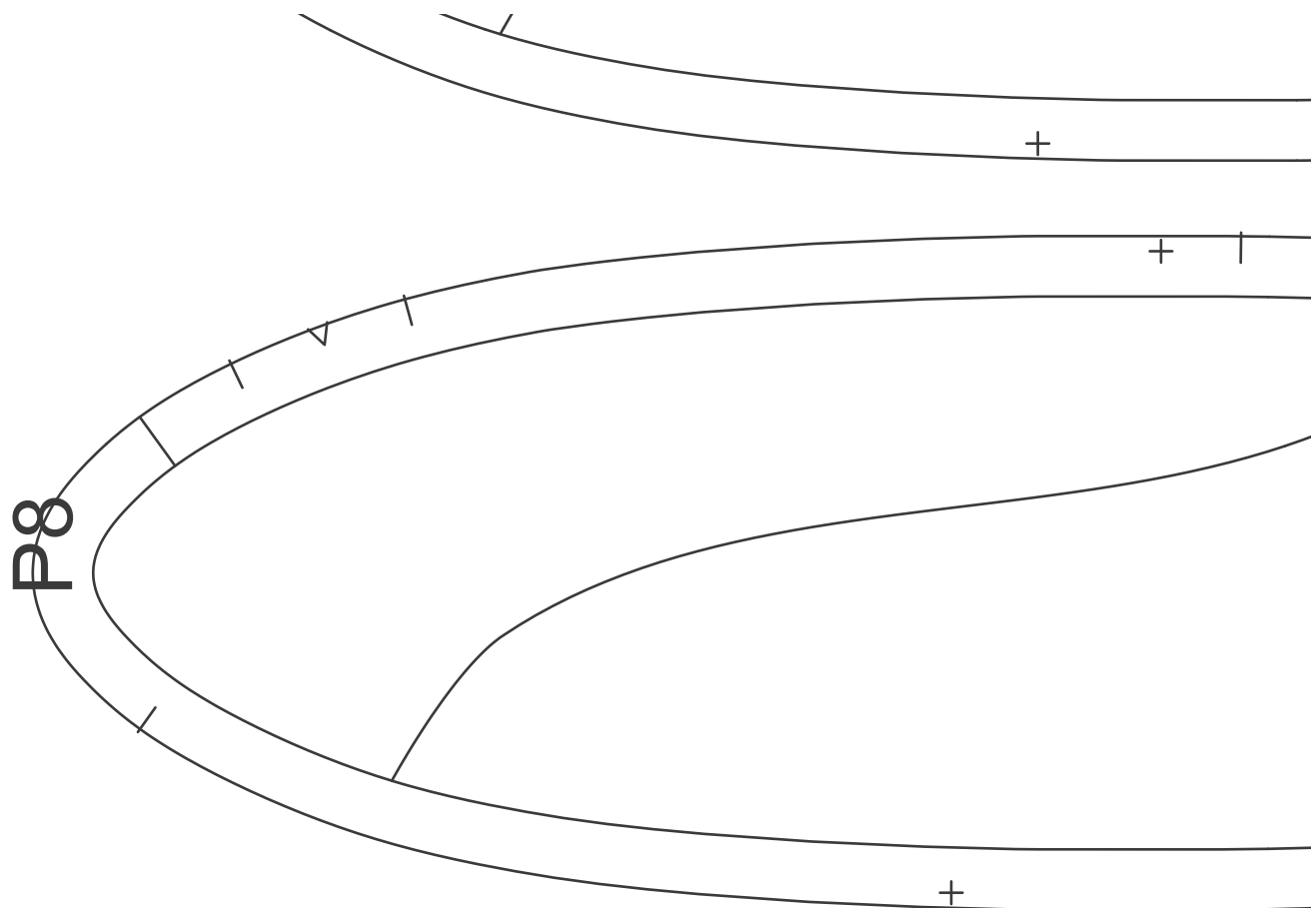

P9

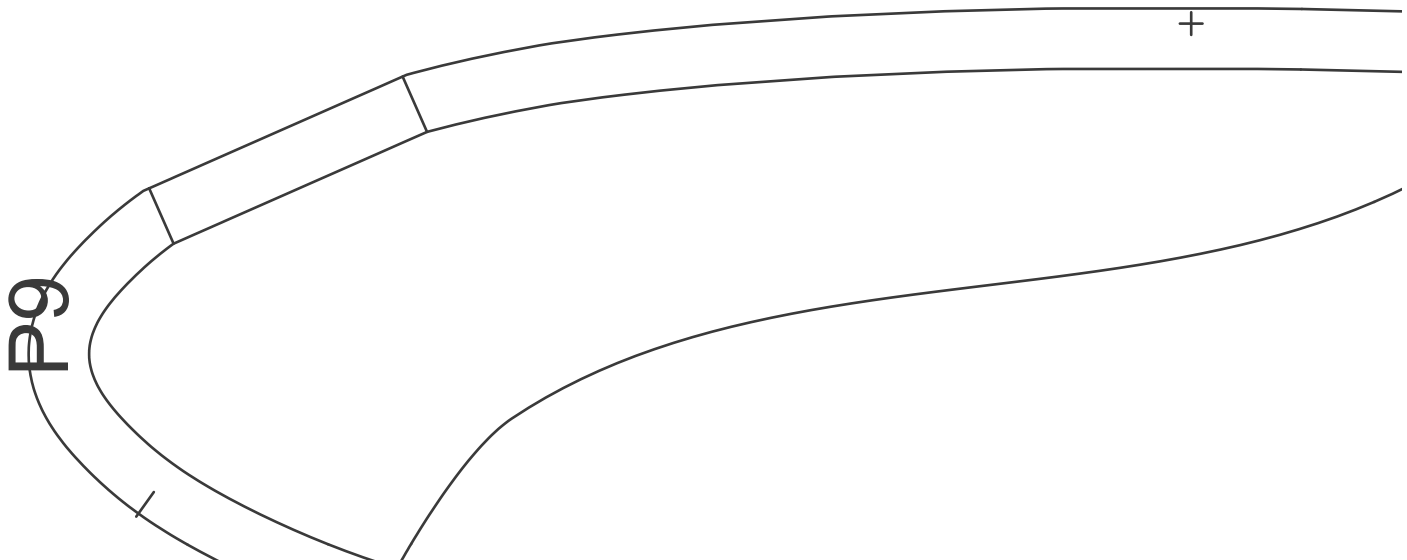

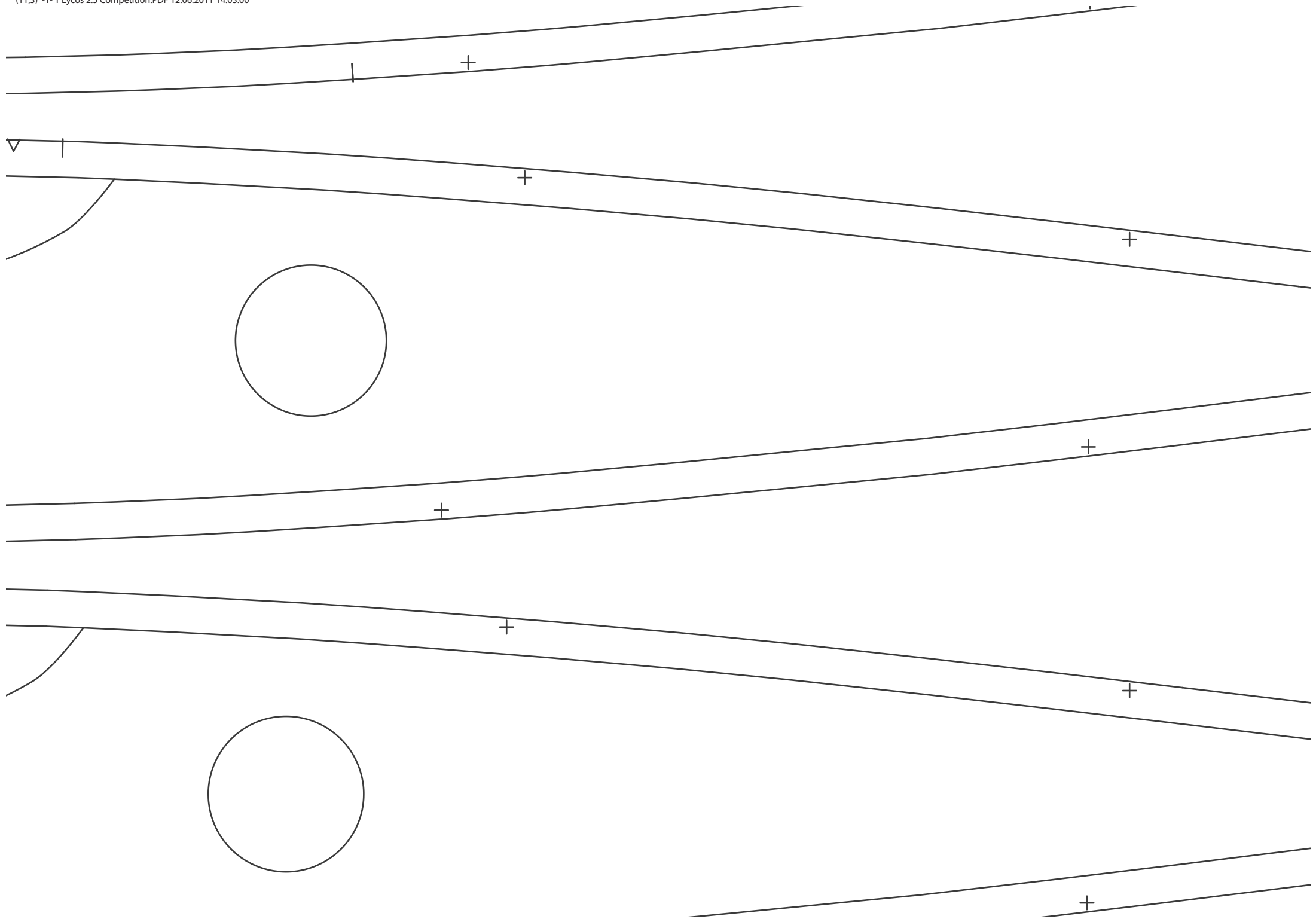

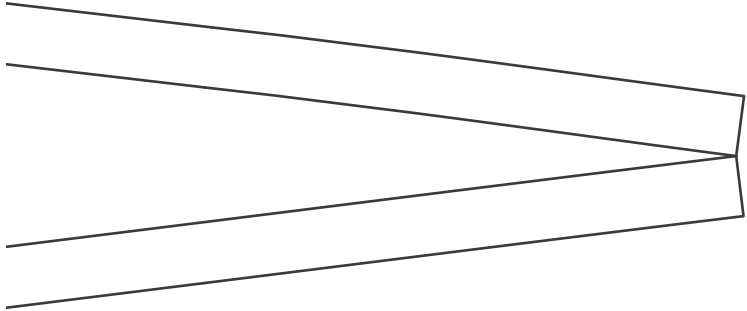
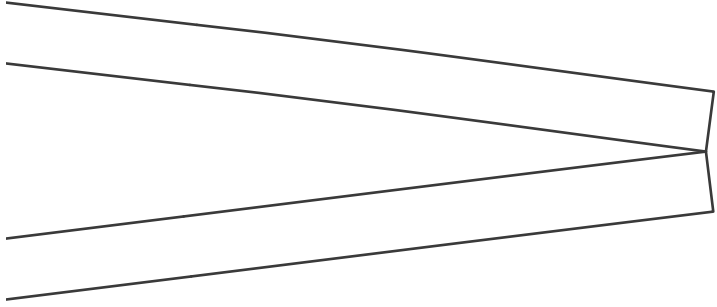

R11

R10

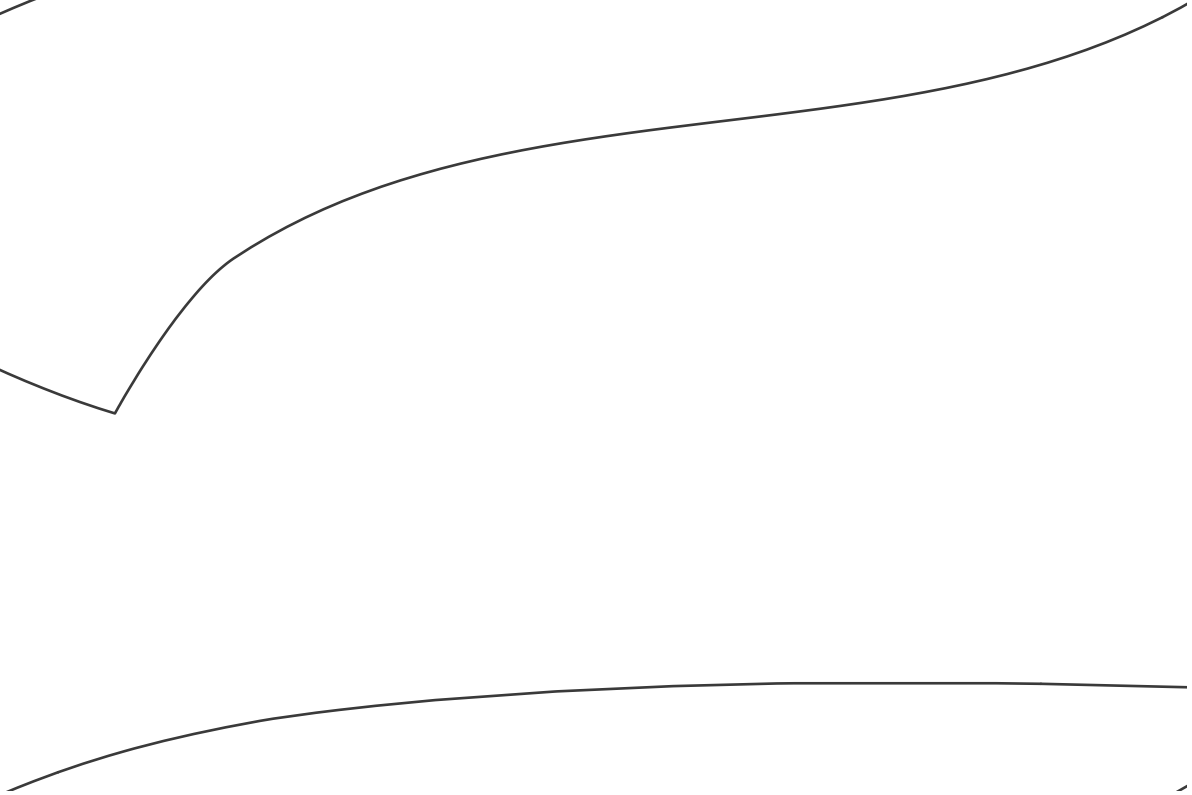
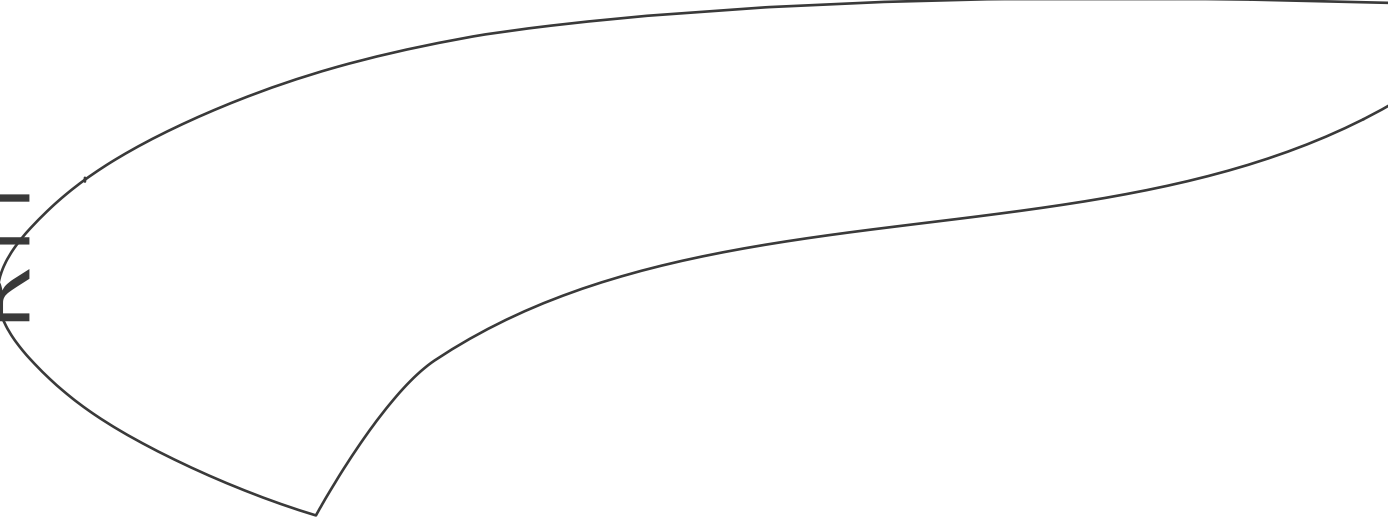
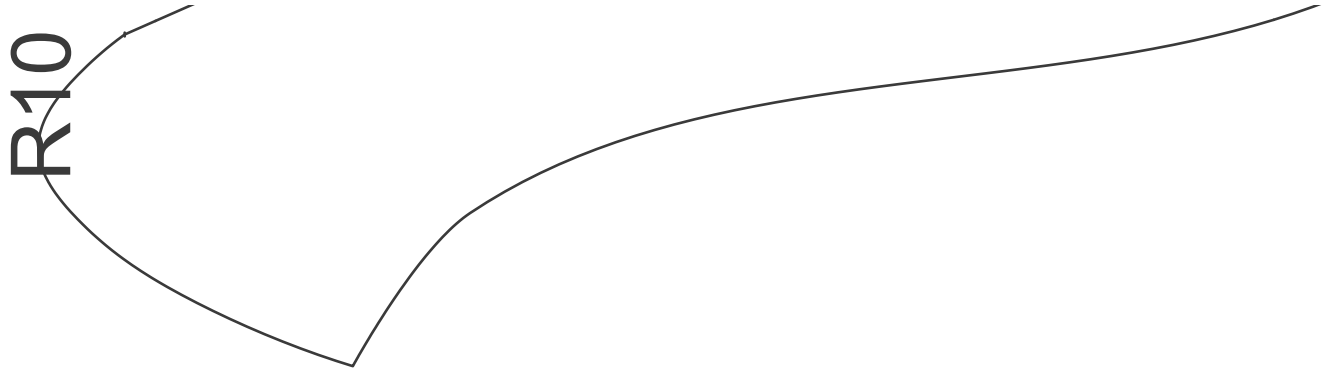



R6

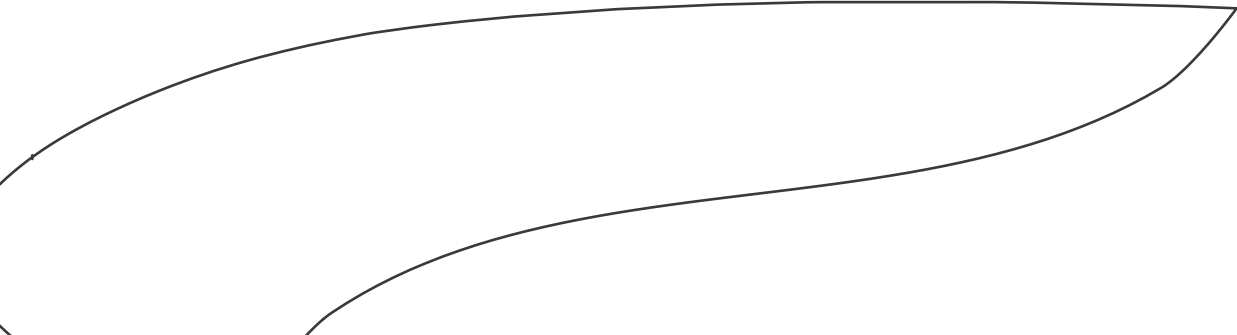

R5

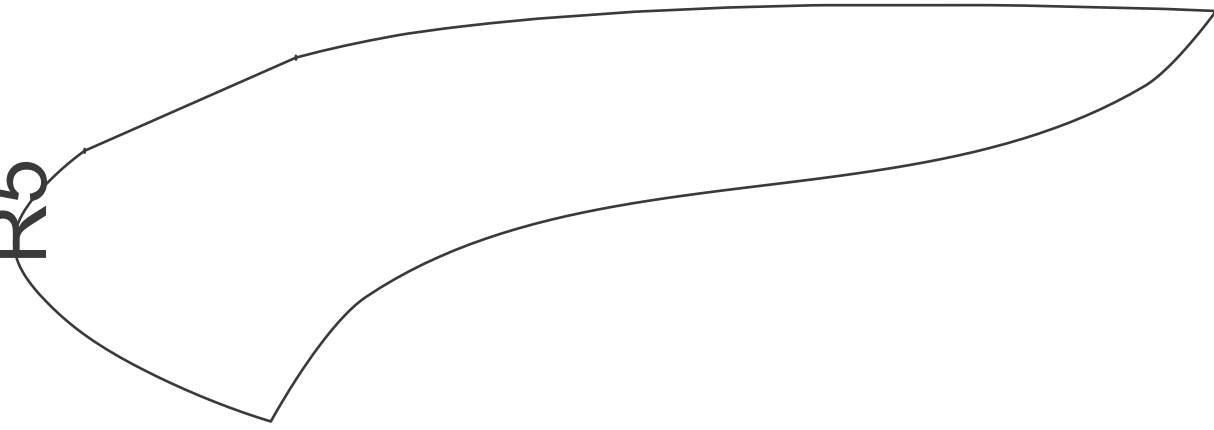

R4

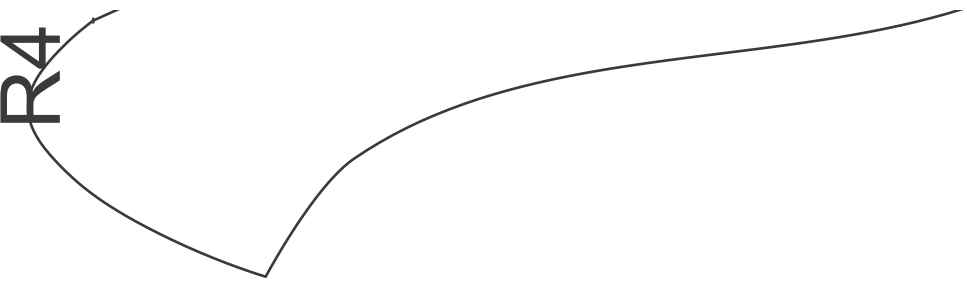

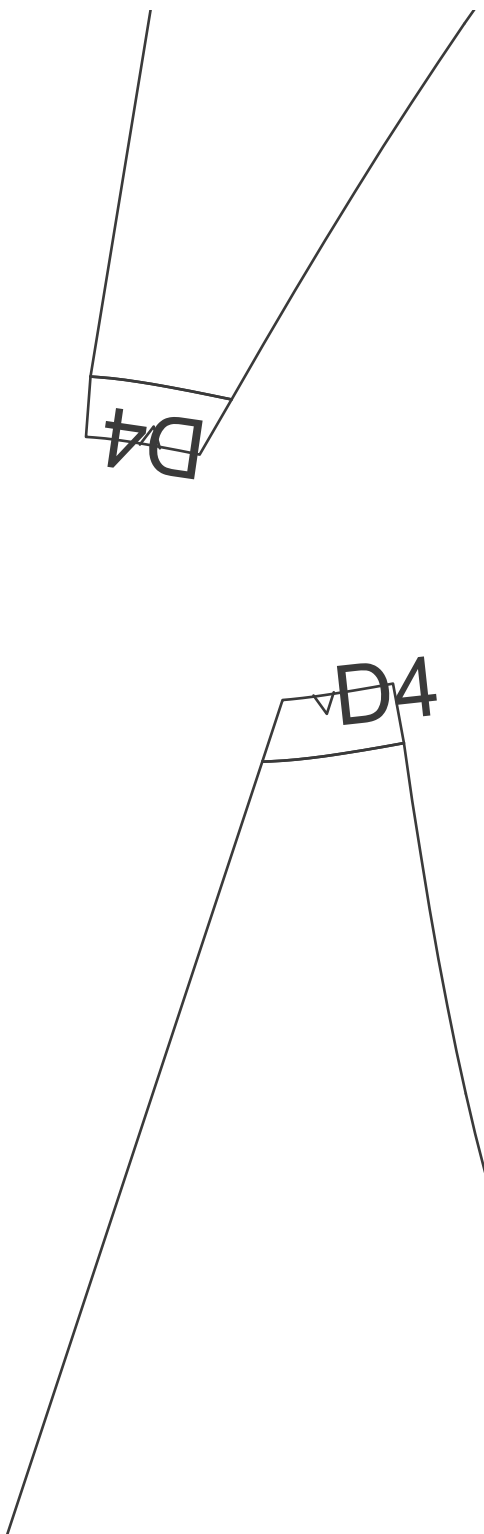
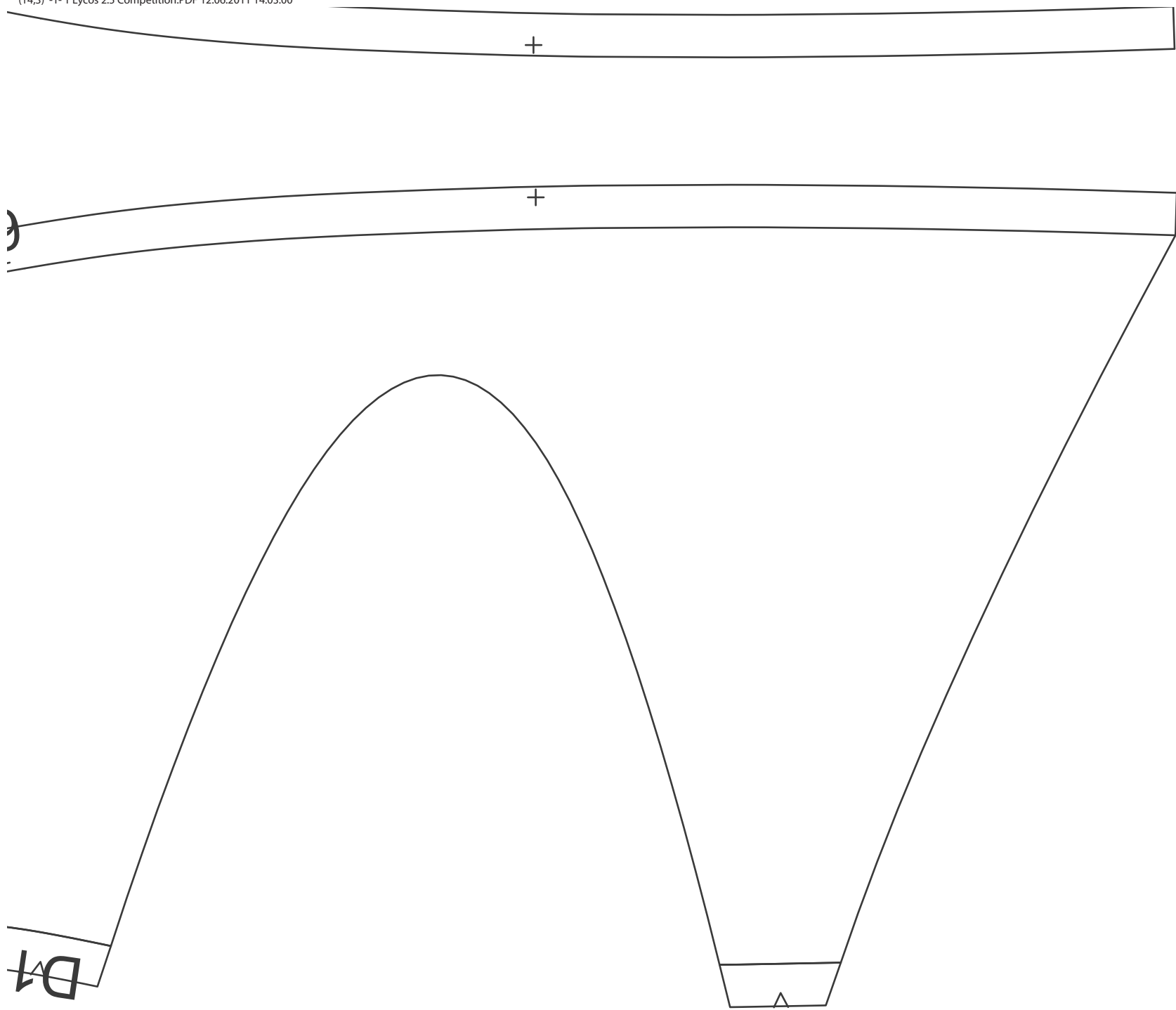

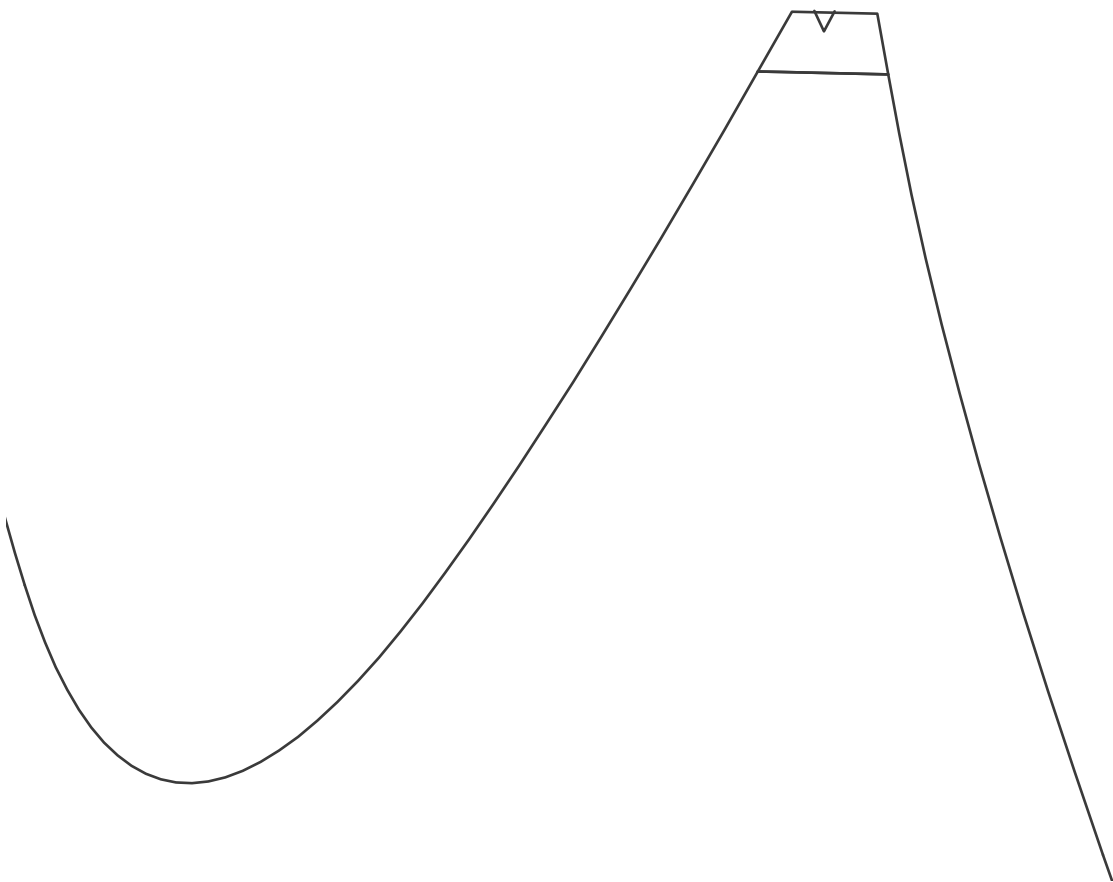
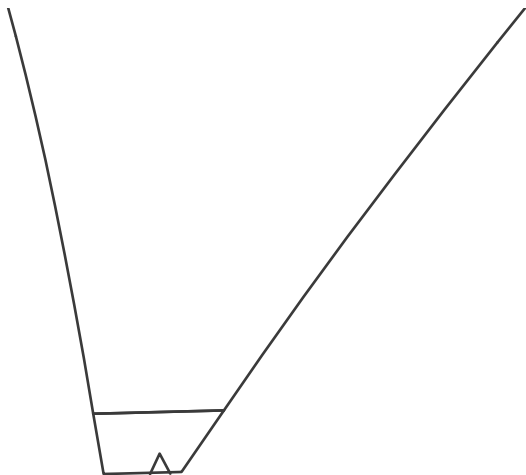

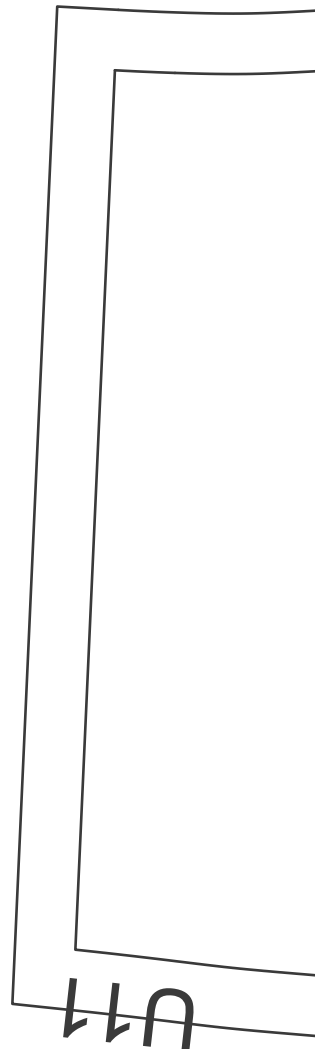

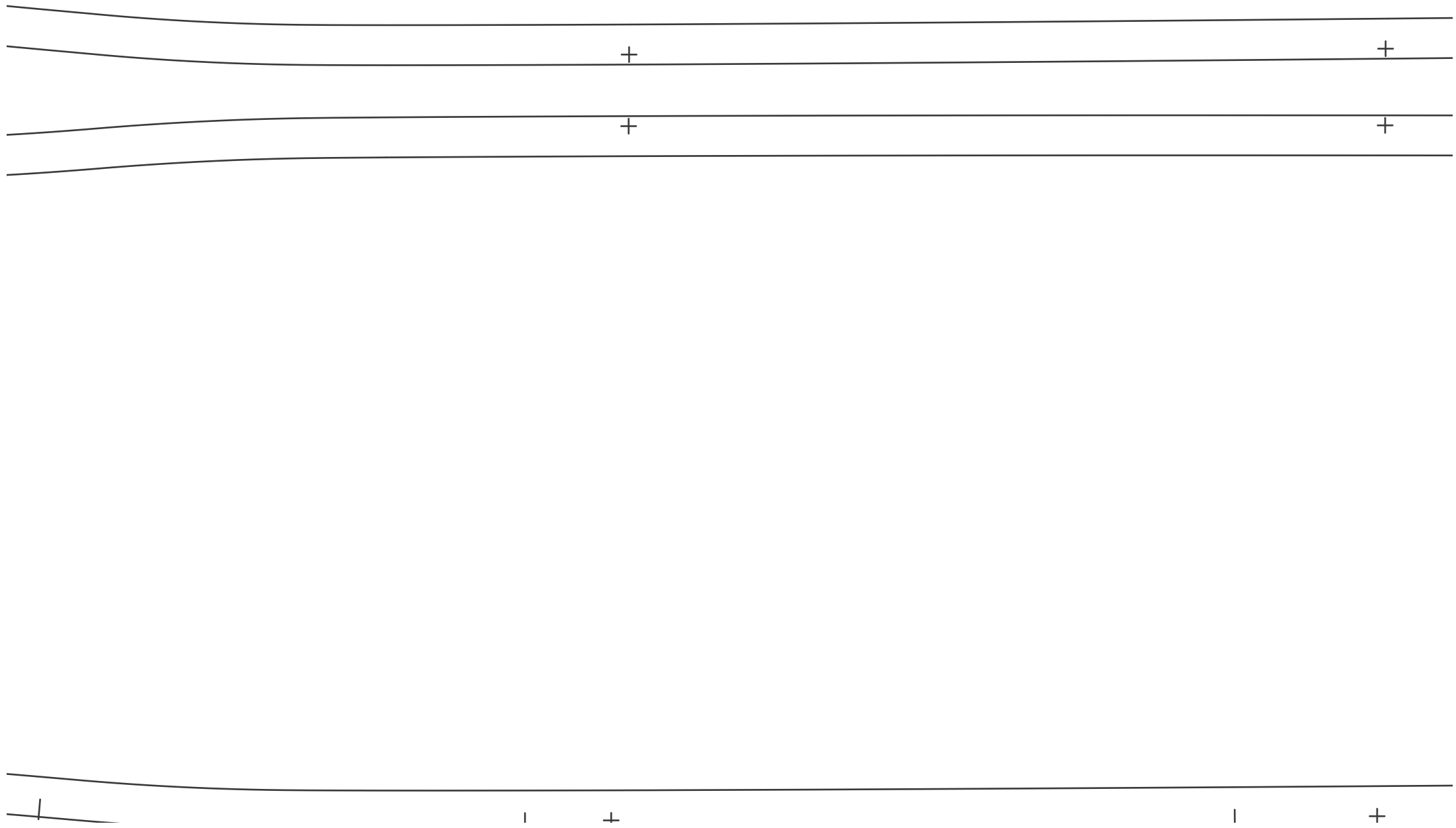

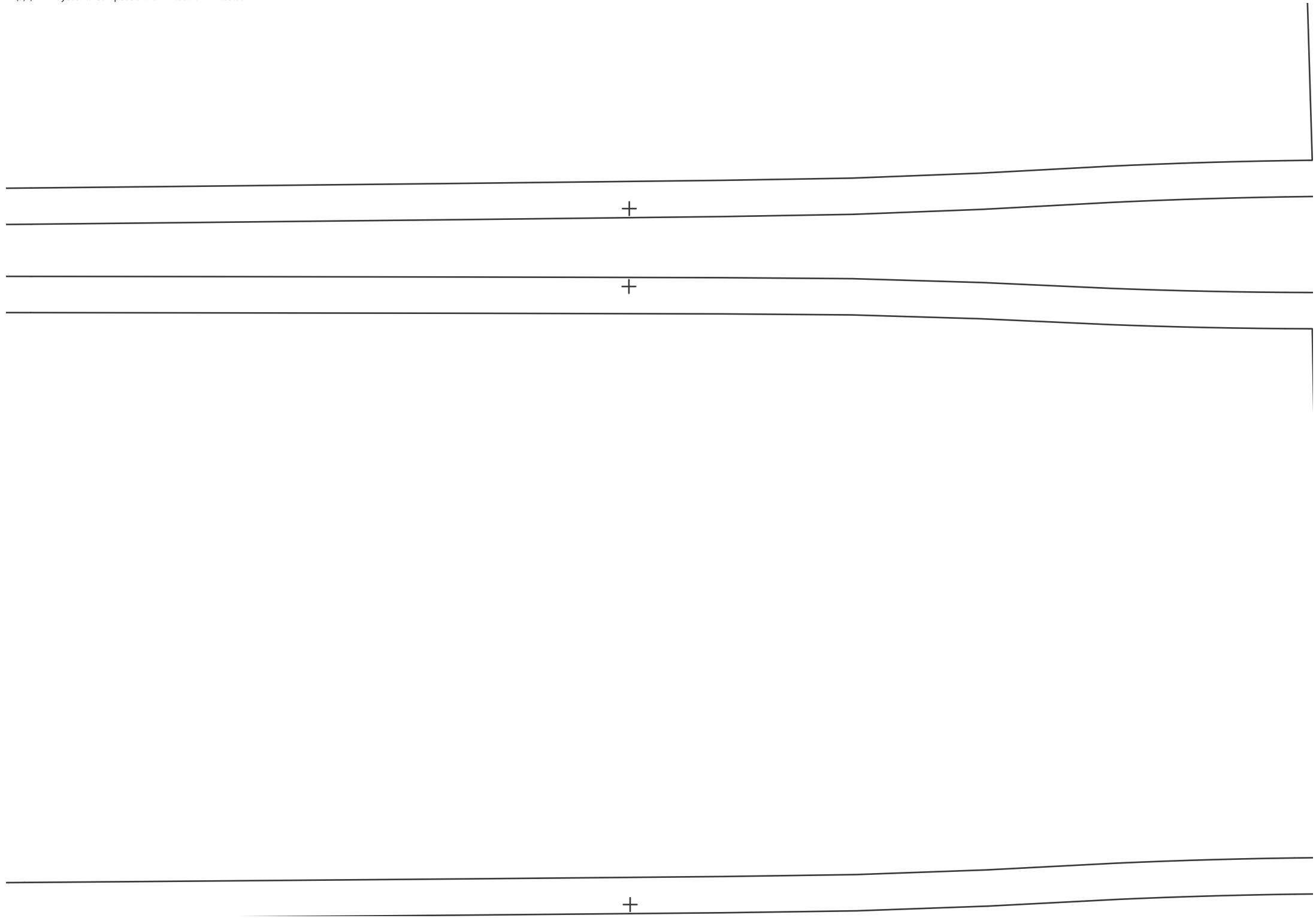

**GRÖS
DIESE**

U5

U6

+

+

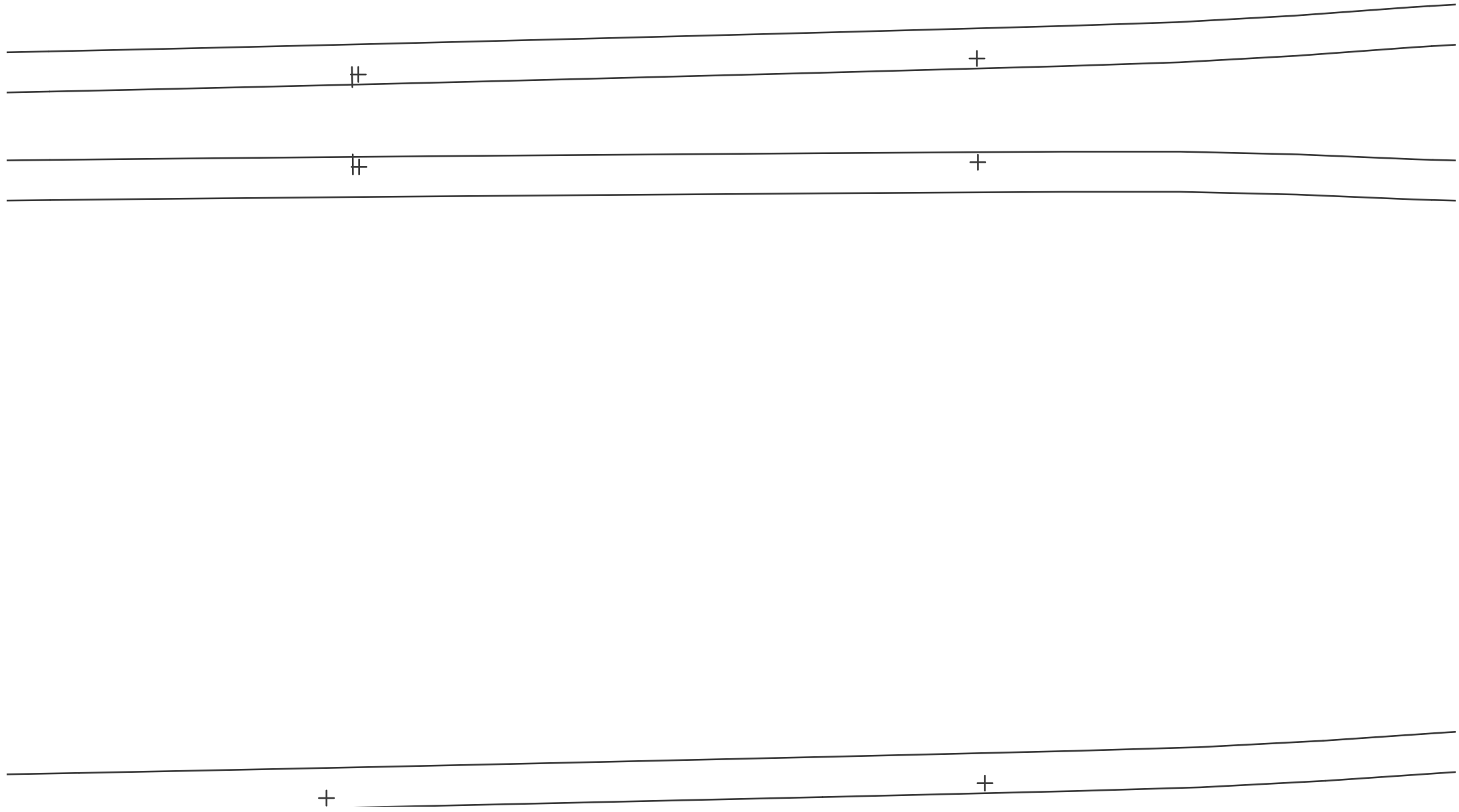

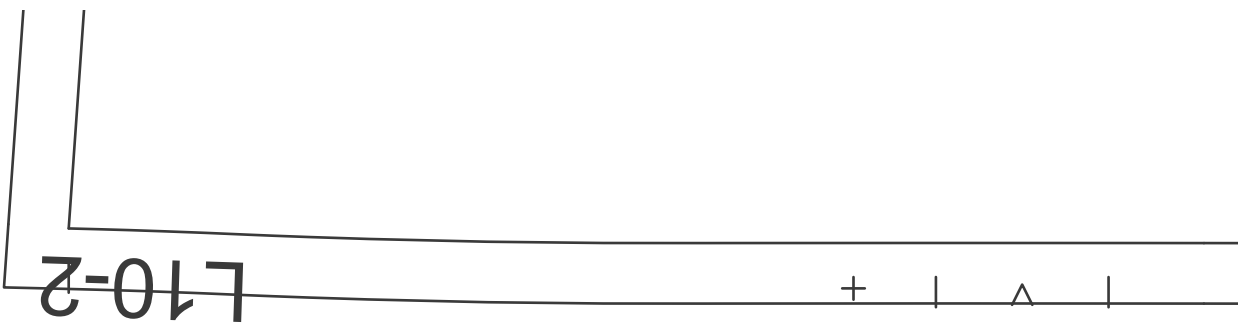
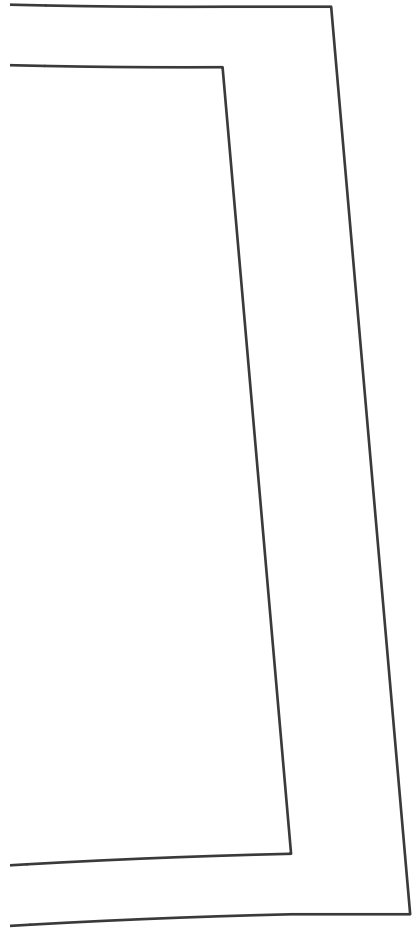
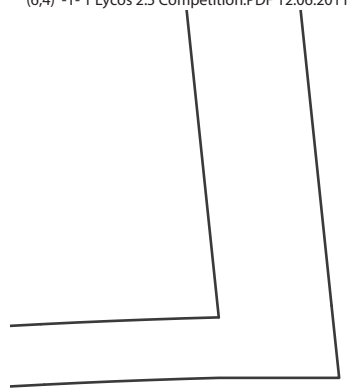

L10-2



L11-2



+

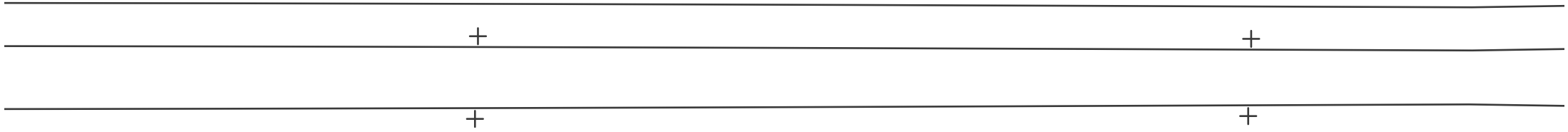
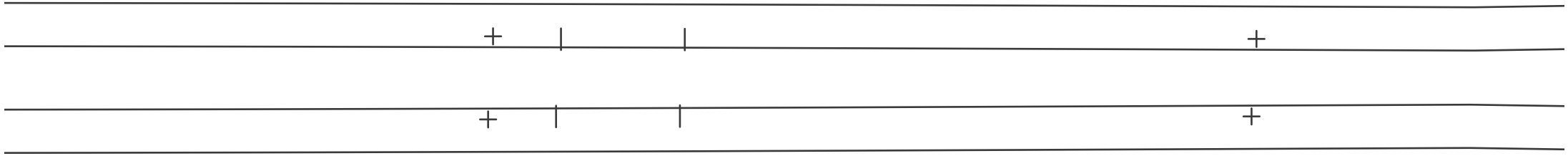

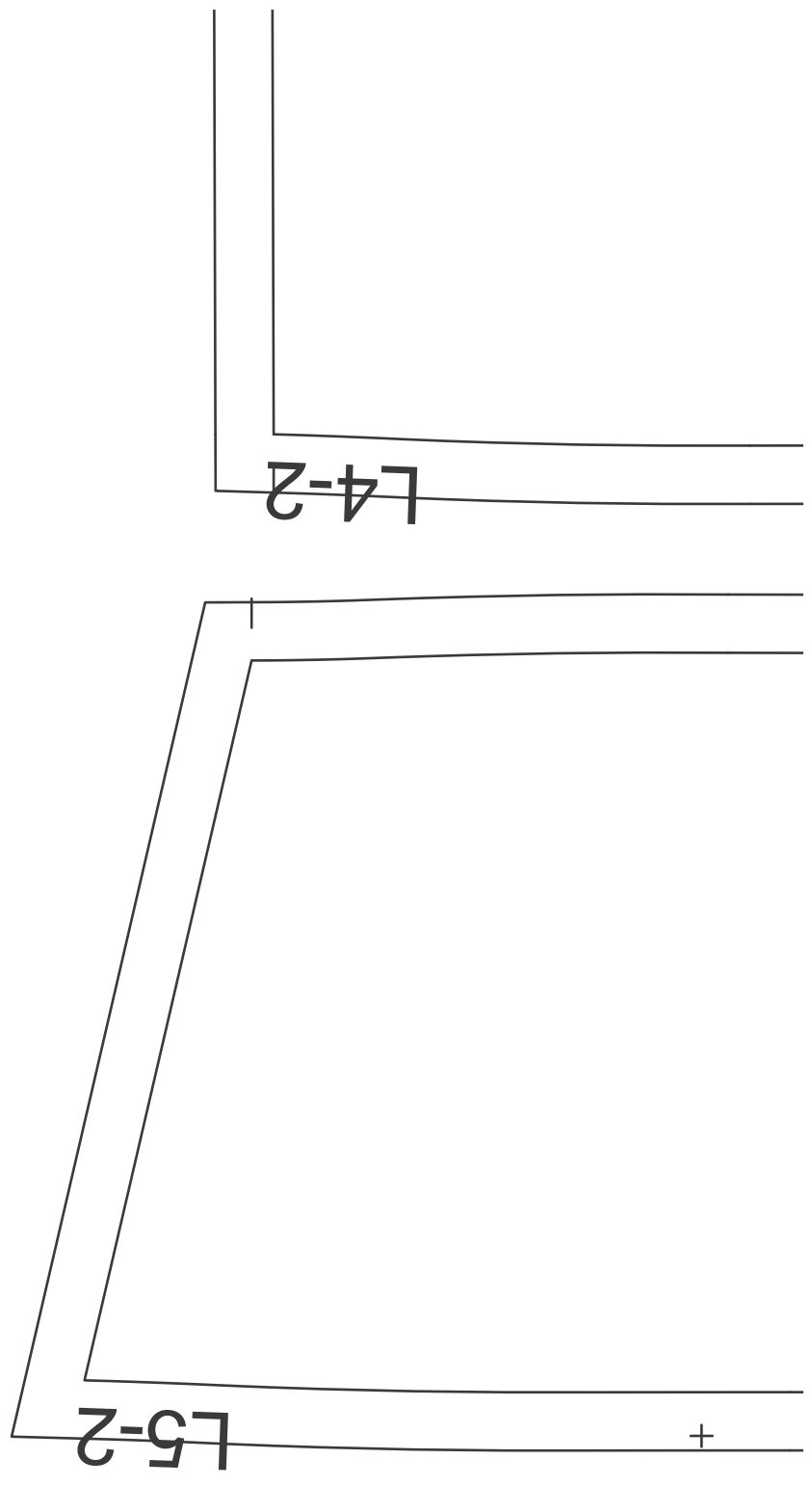
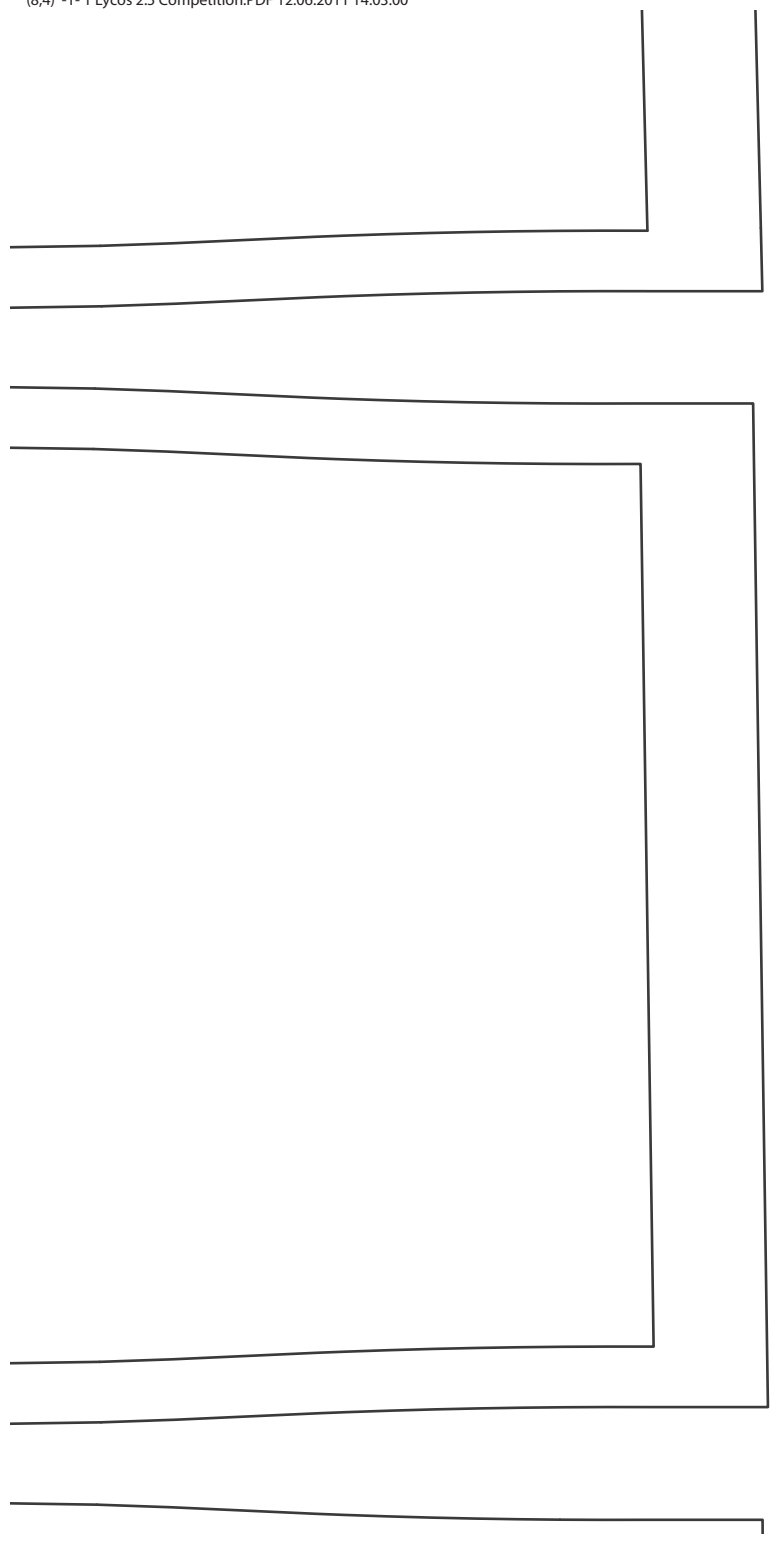



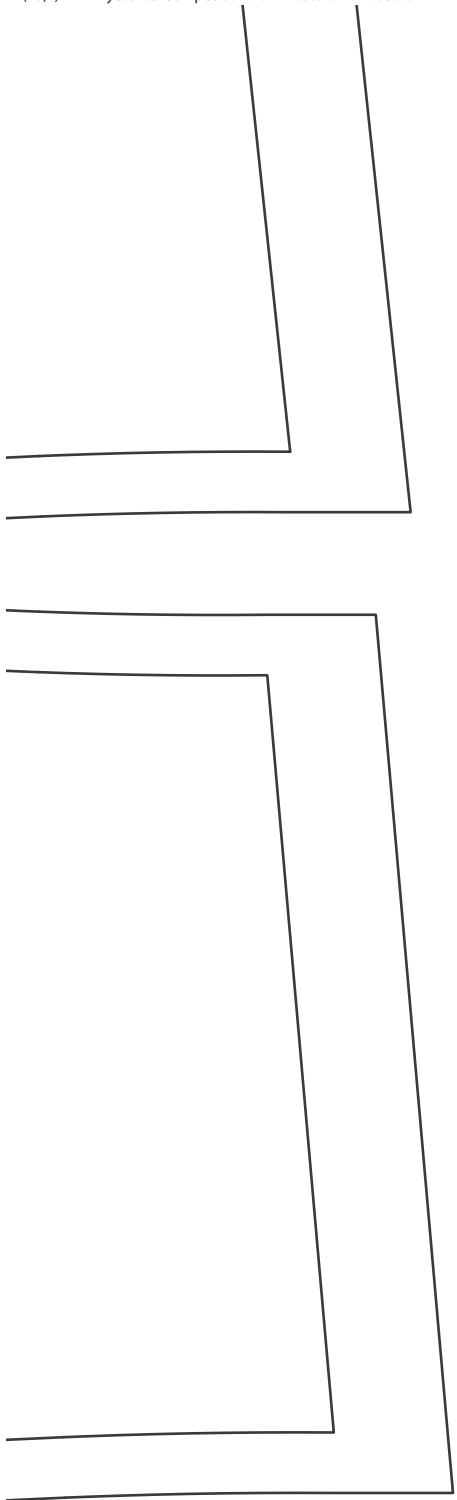

P11

P10

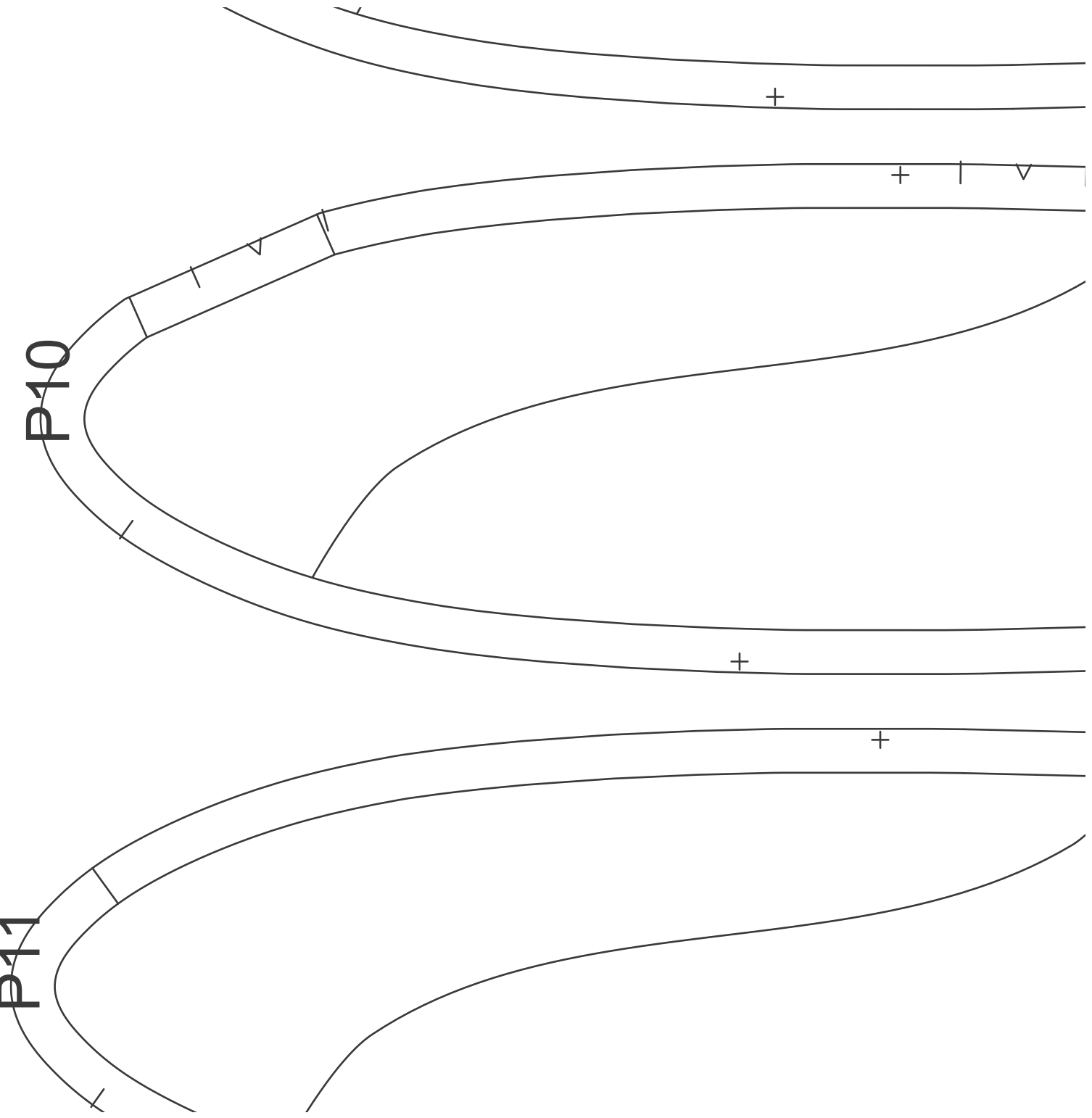

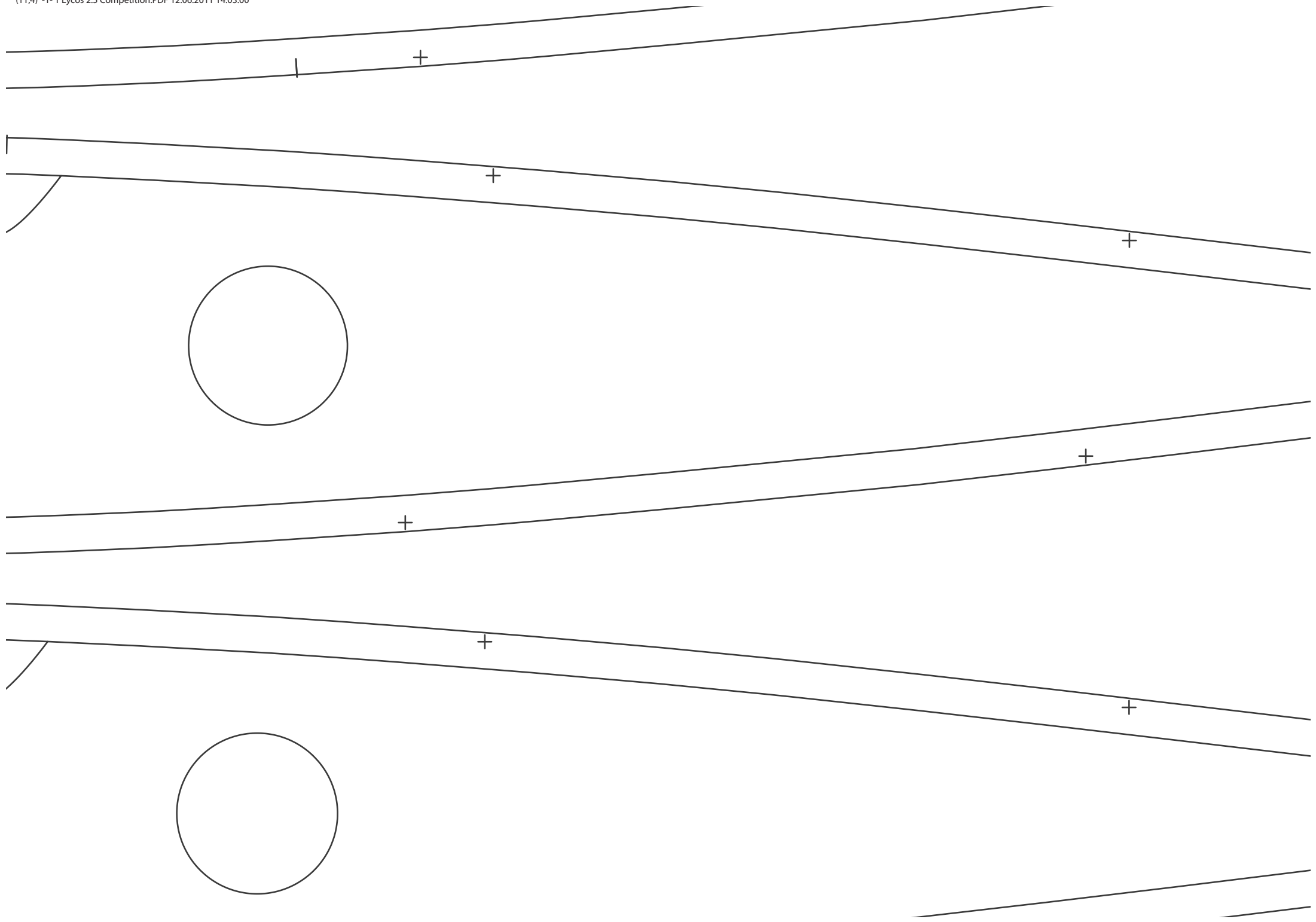

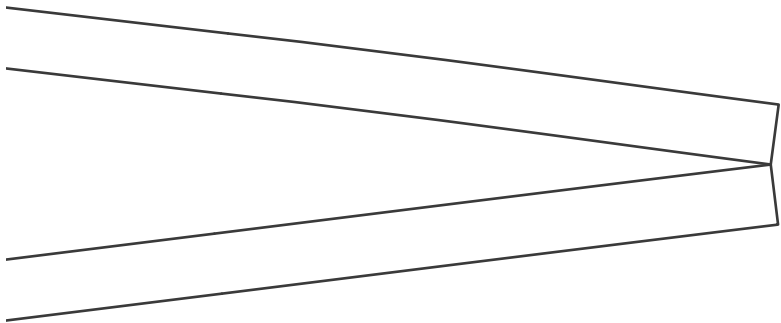
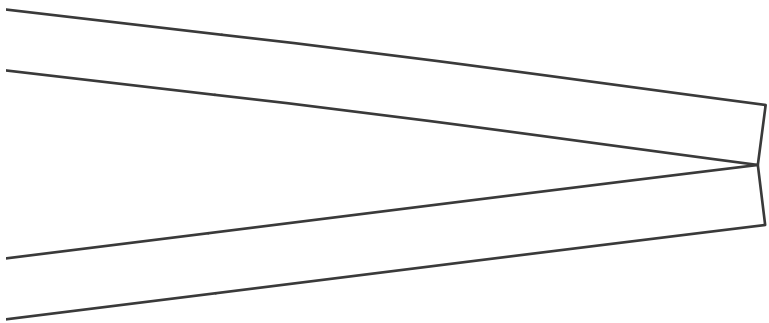

R12

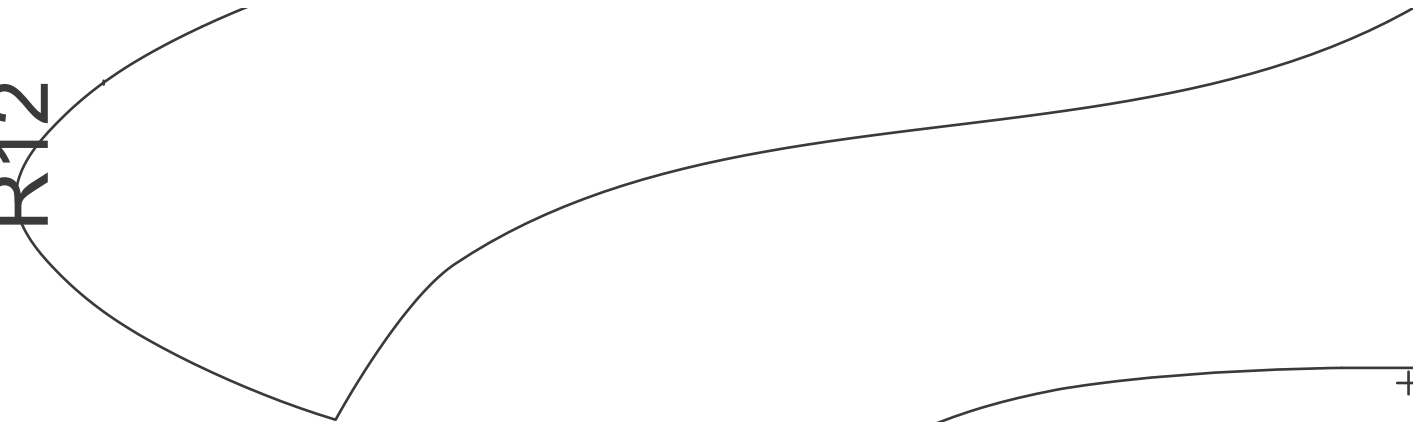

P2

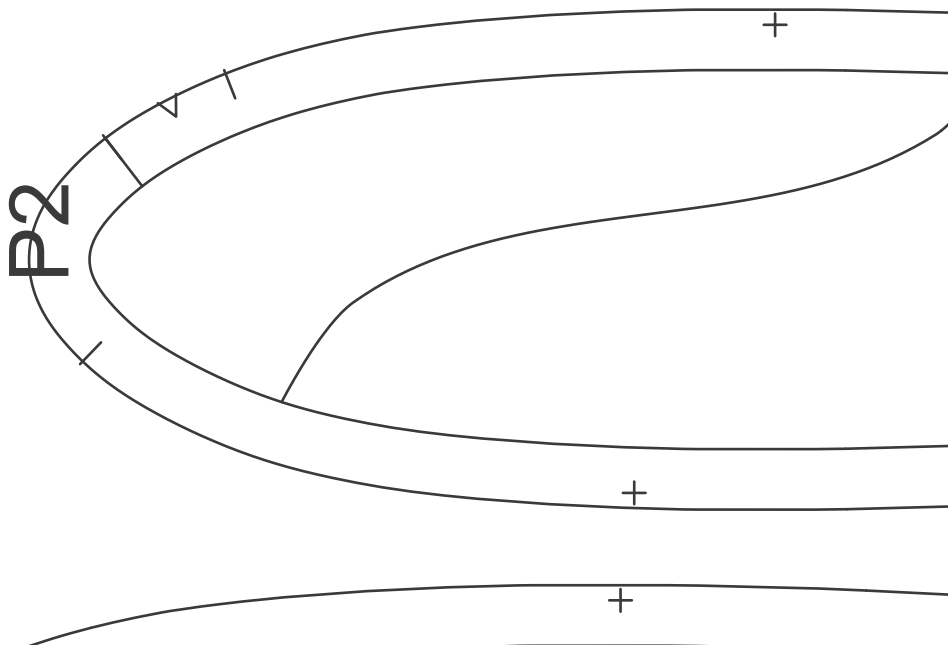

P1

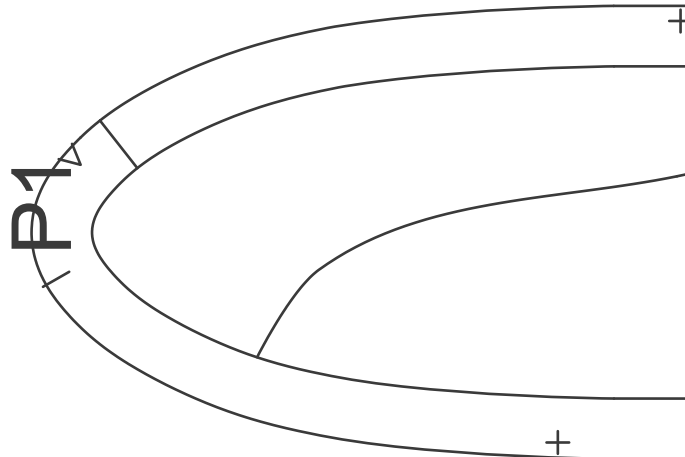

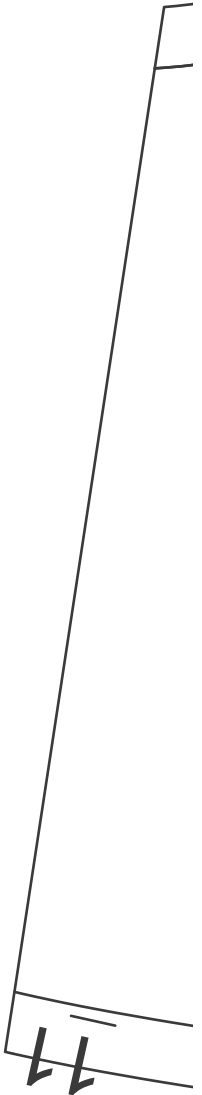
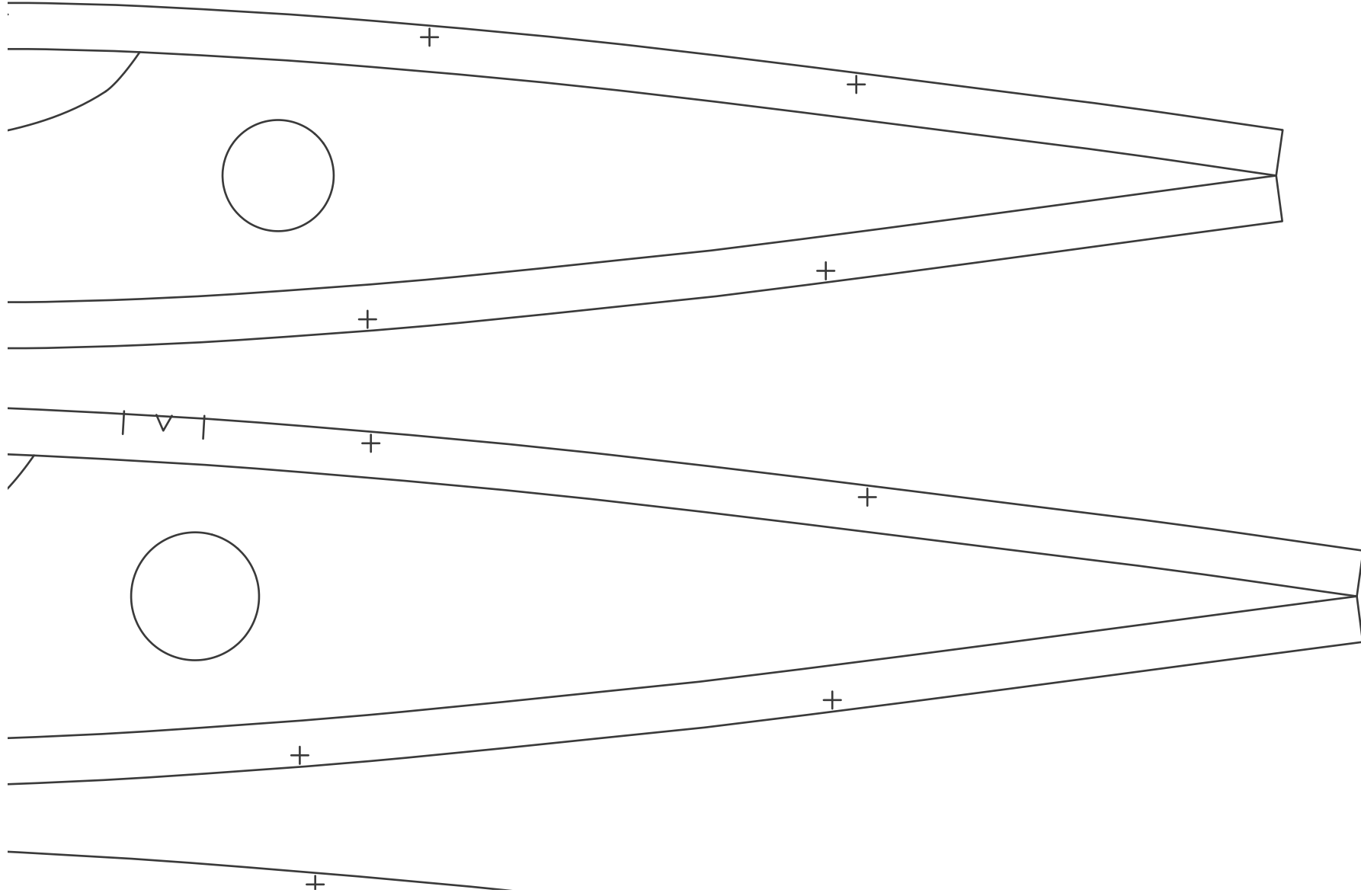
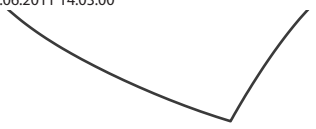

D10

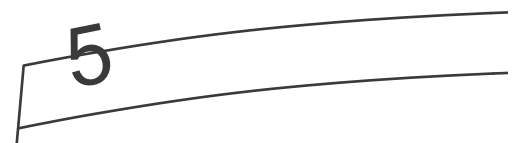
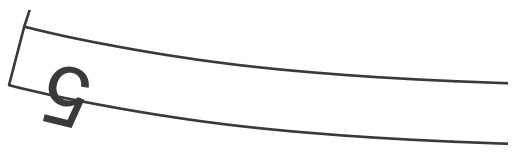
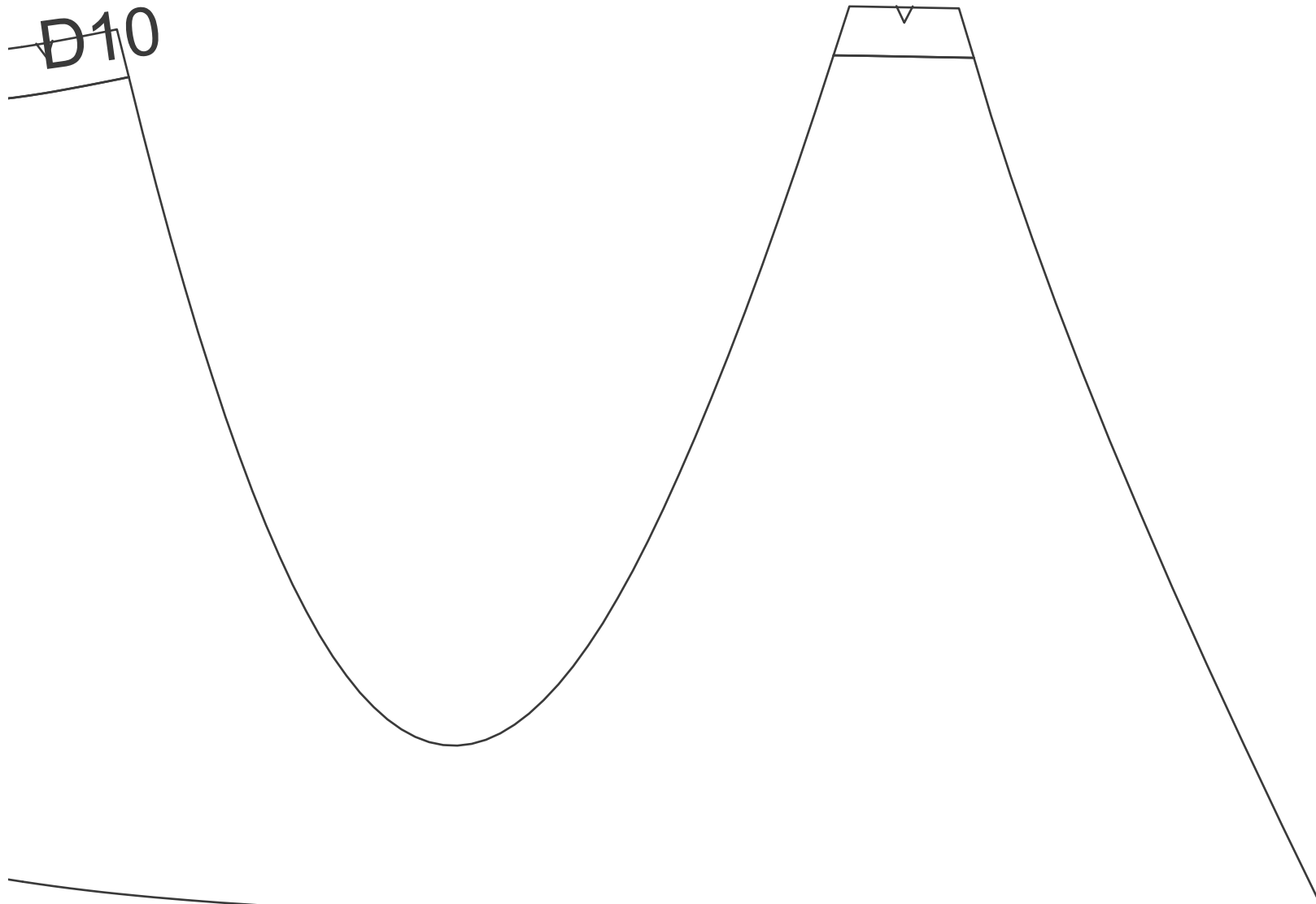

D6

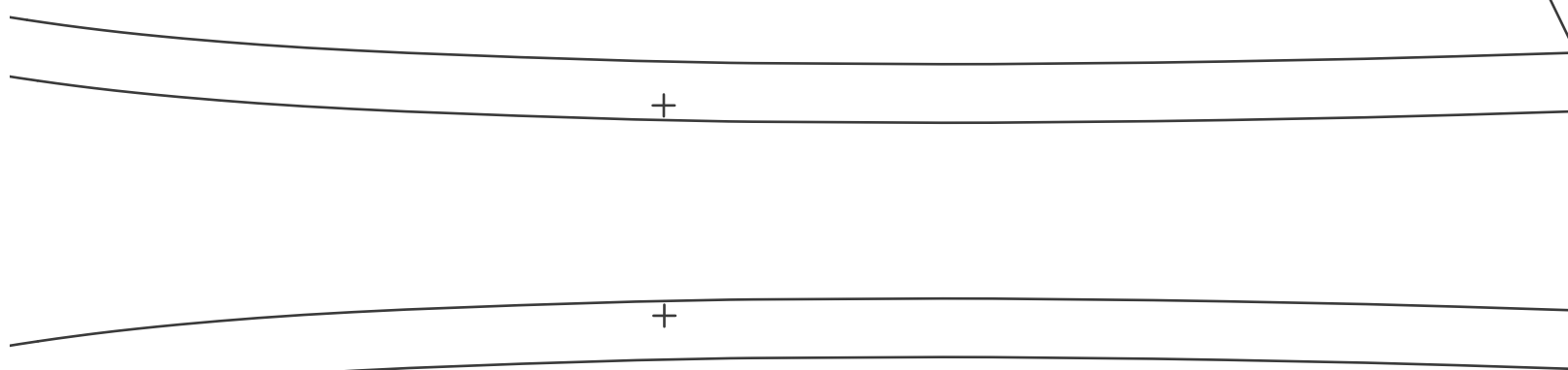

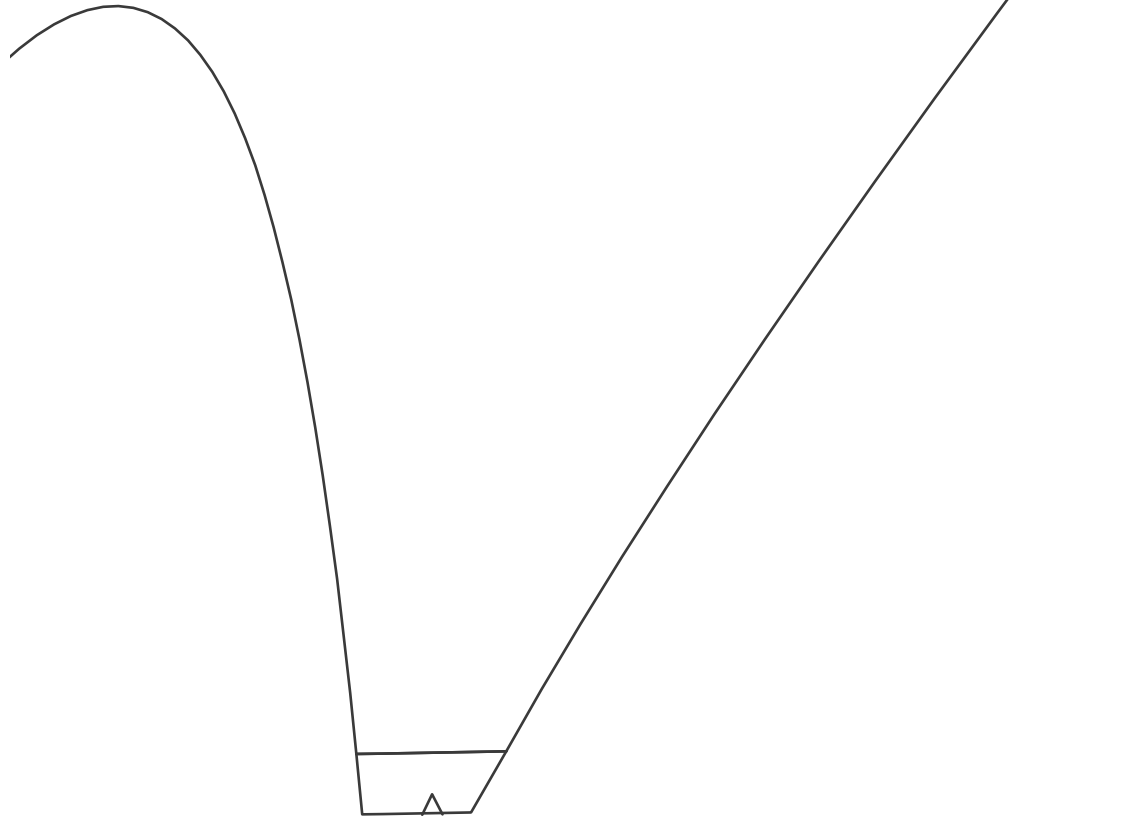
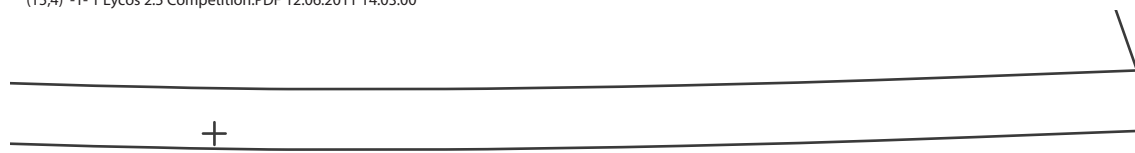

U12

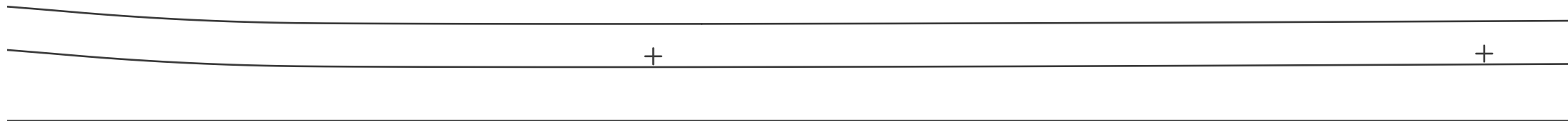
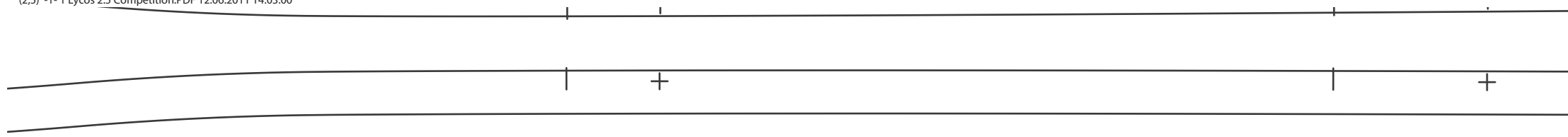

+

+

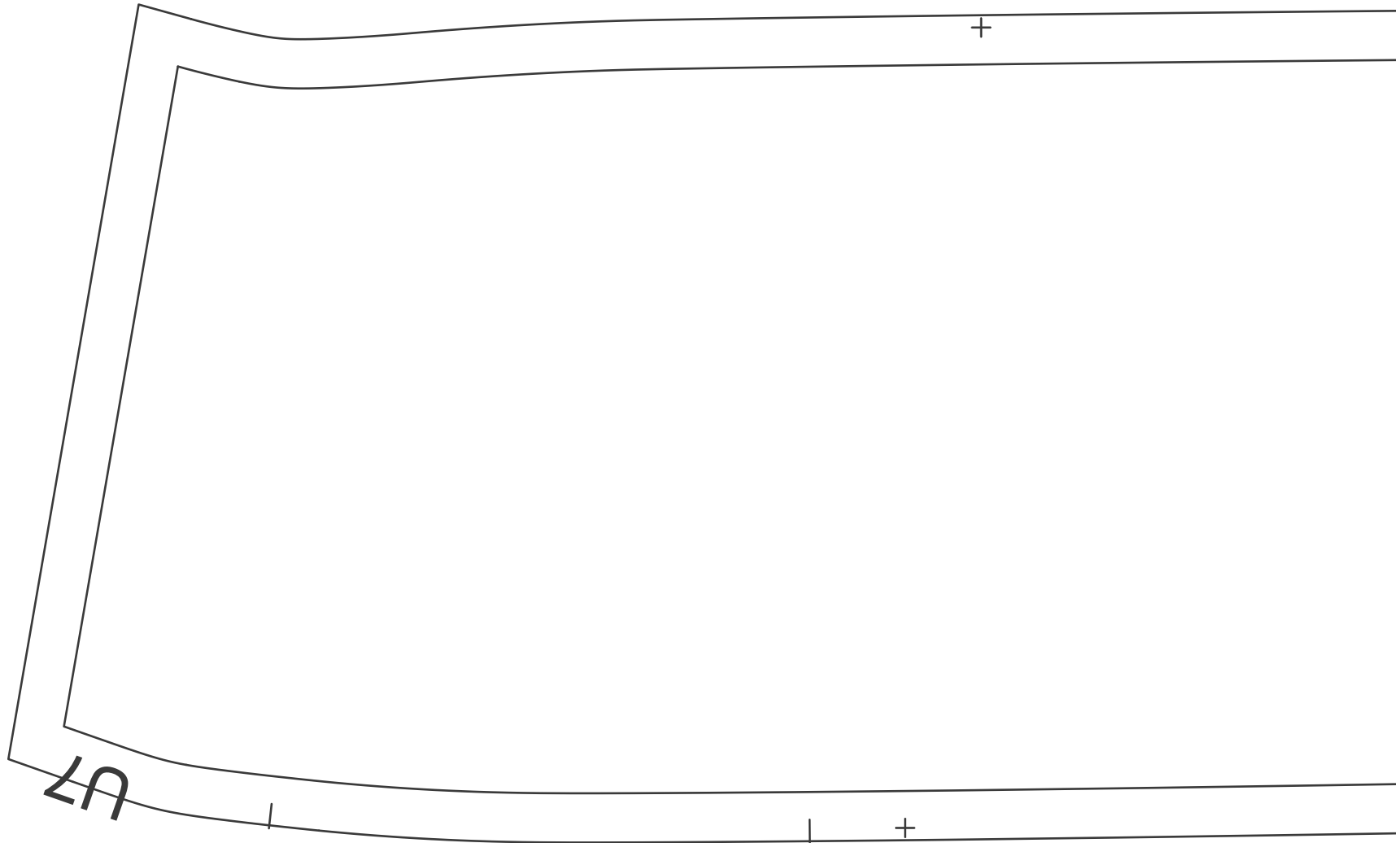
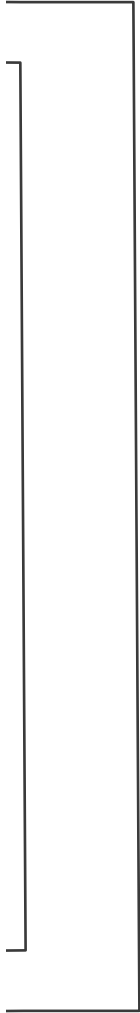

+

+

|

+

+

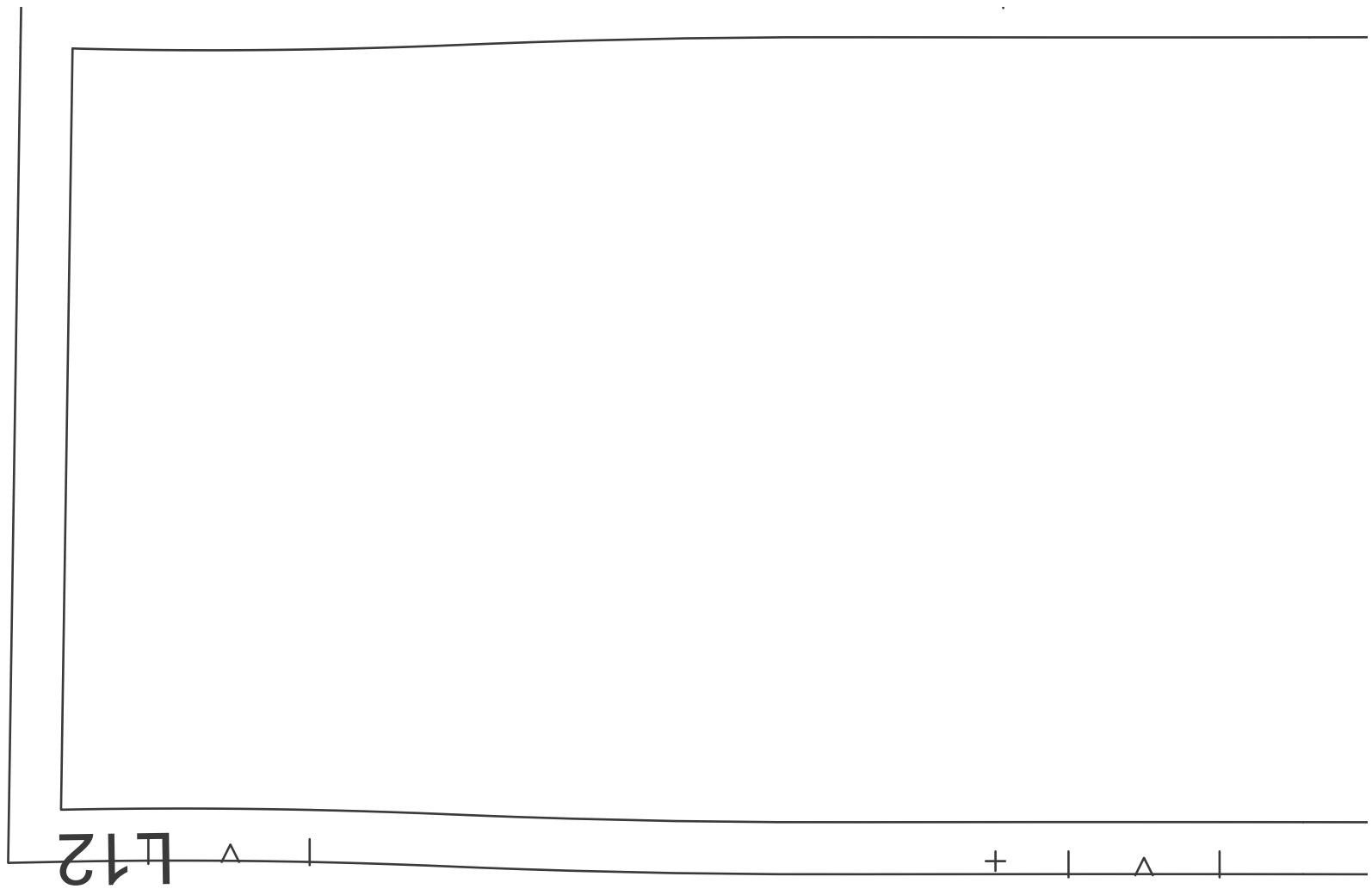
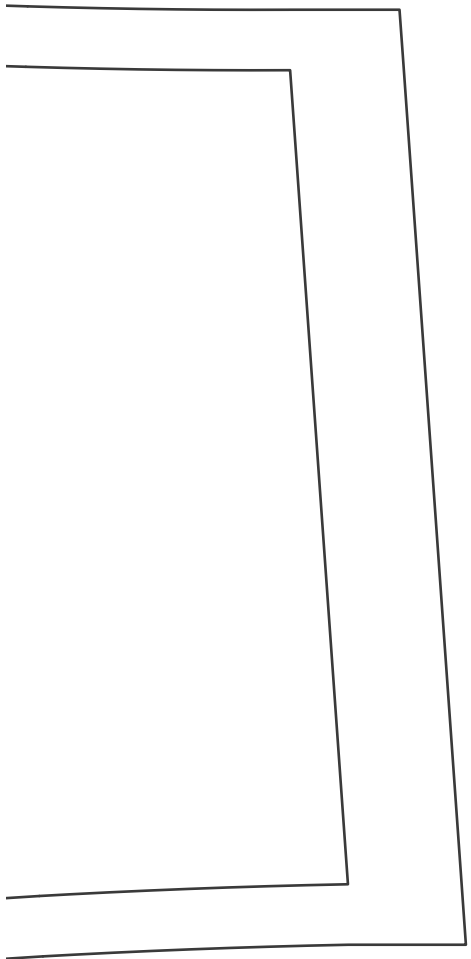

L12



+

|

|

+

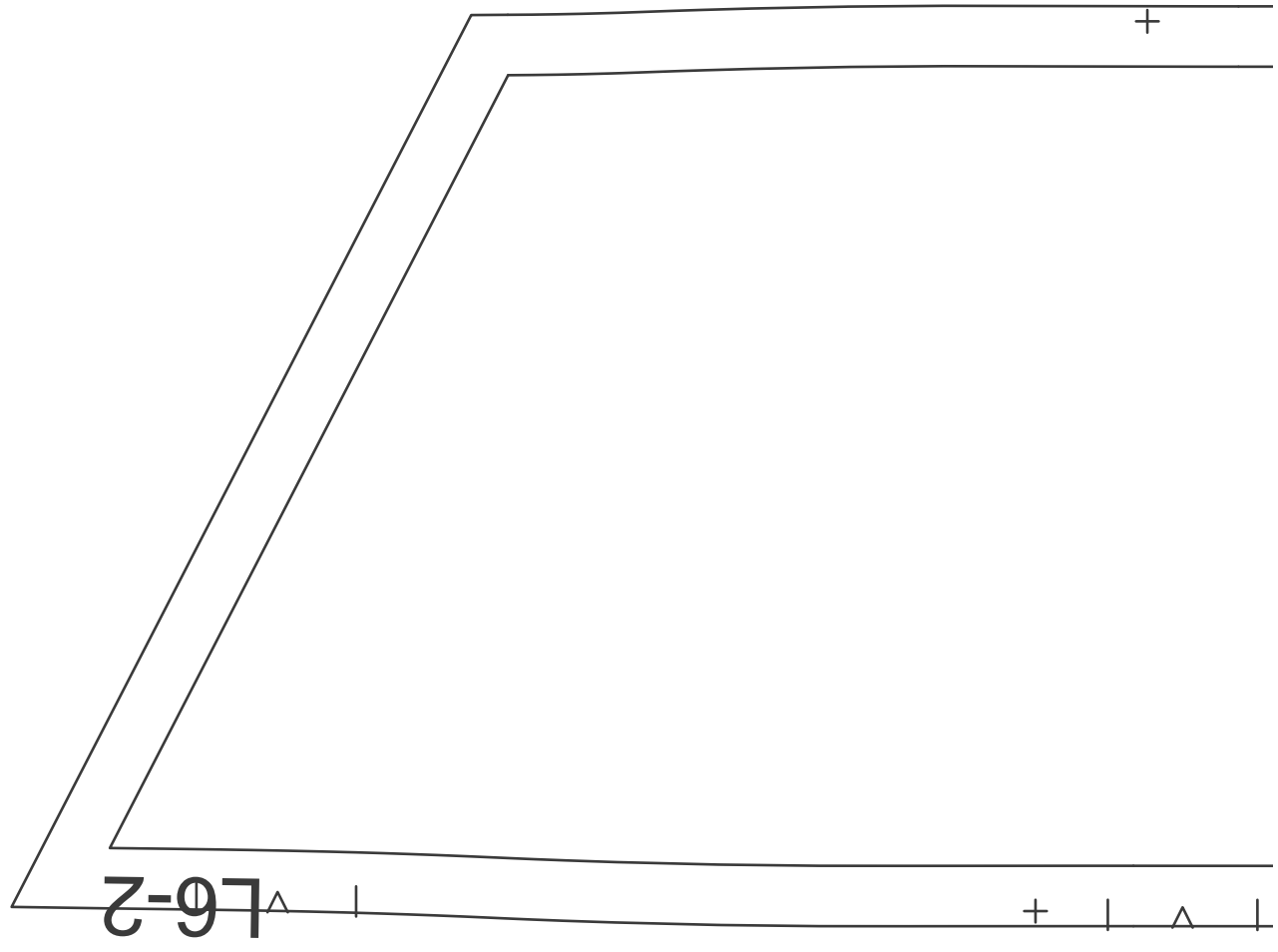
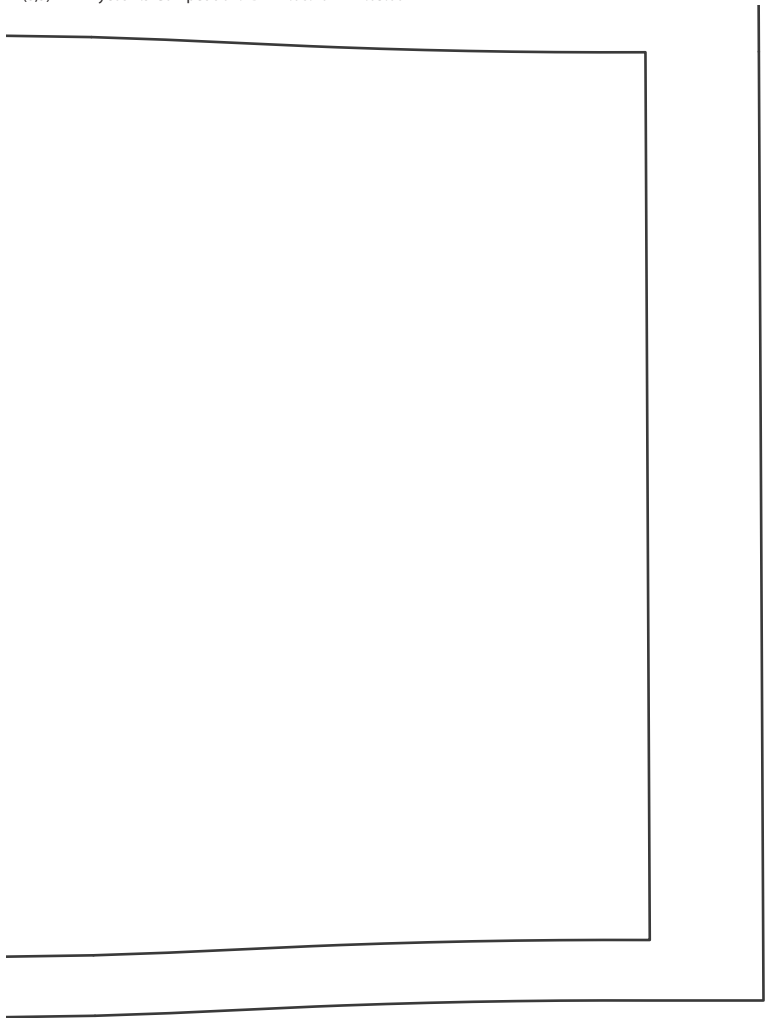

+

+

+

|

|

+

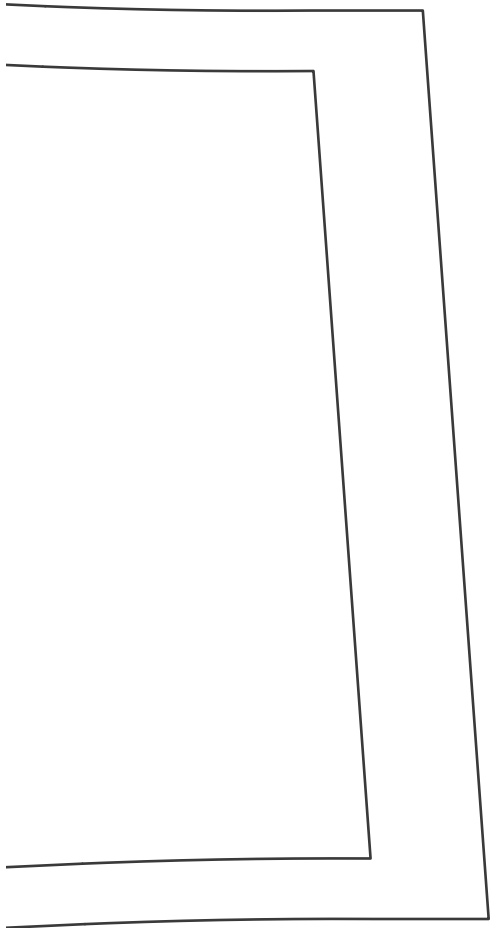

P12

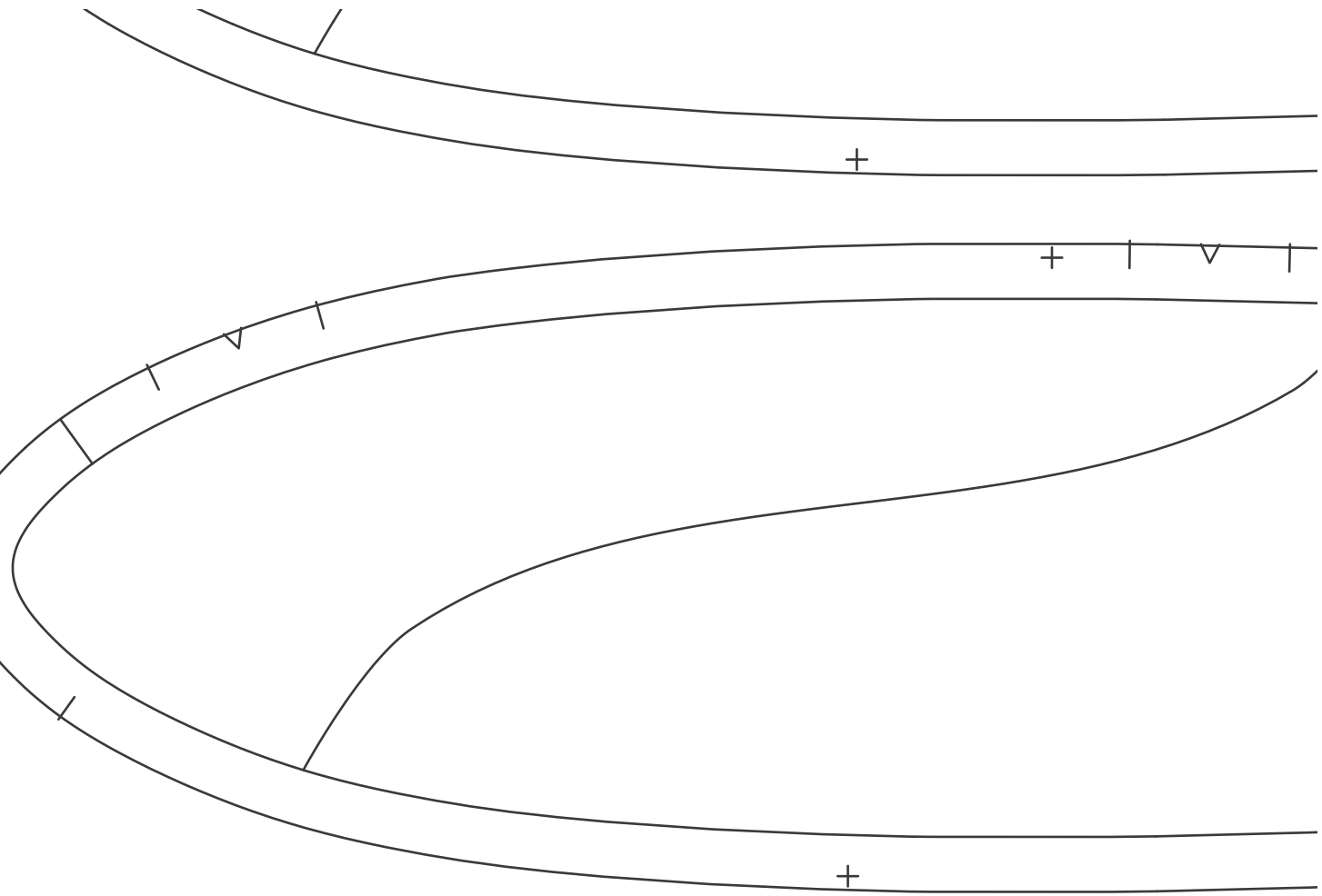

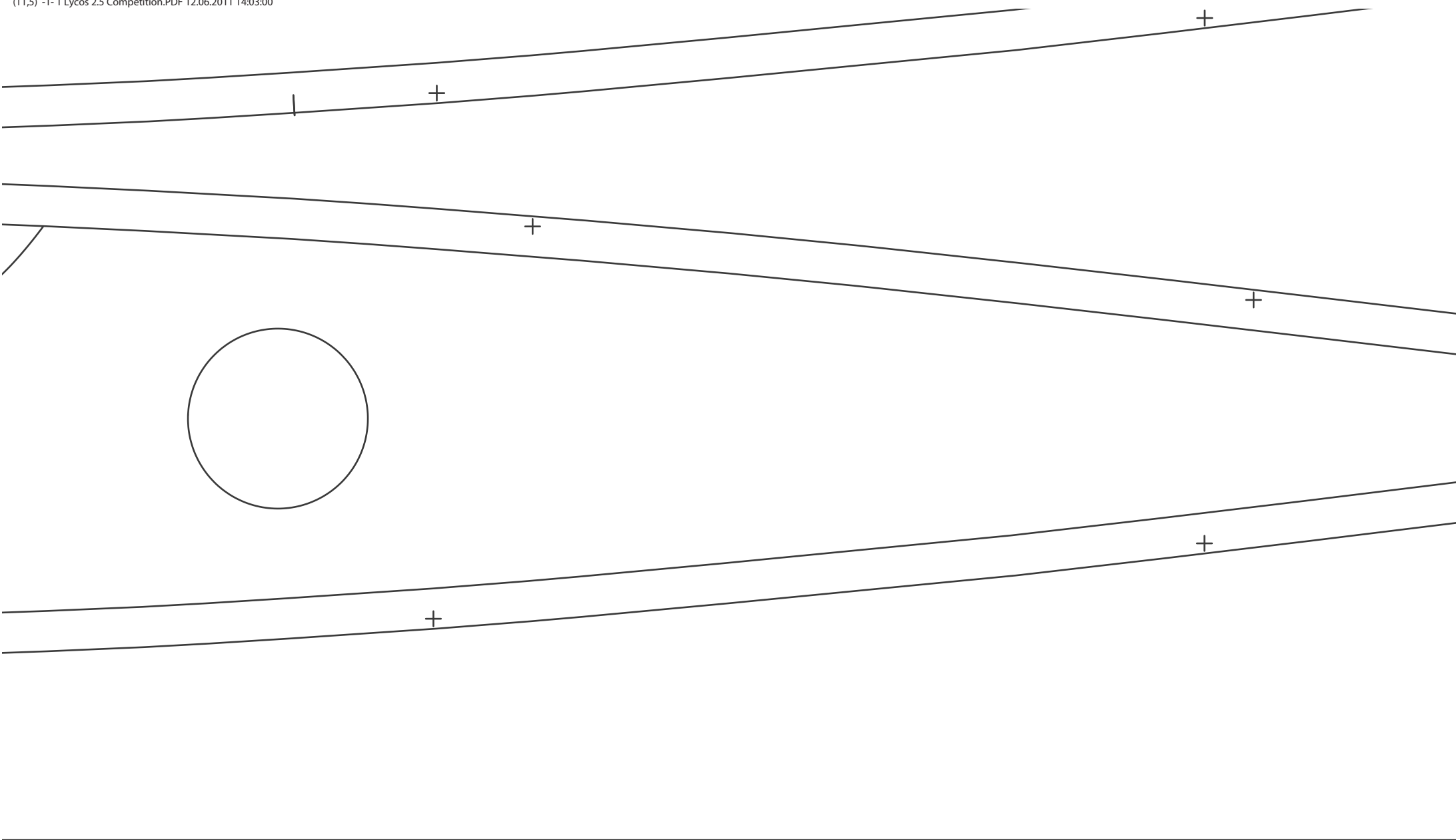

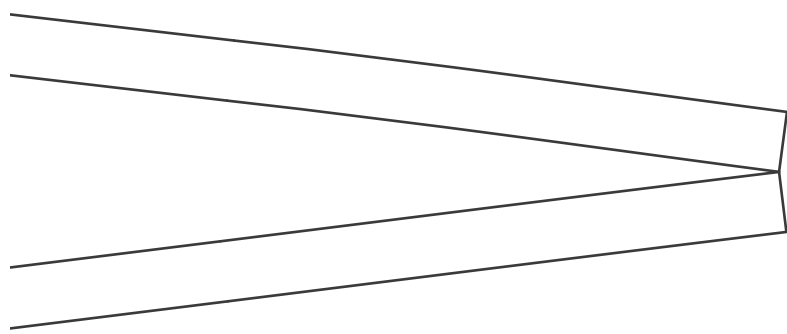

P4

